



m

PCT

WORLD INTELLECTUAL PROPERTY ORGANIZATION  
International Bureau

## INTERNATIONAL APPLICATION PUBLISHED UNDER THE PATENT COOPERATION TREATY (PCT)

<p>(51) International Patent Classification <sup>7</sup> : C12N 15/85, 15/62, 5/10, C07K 16/30, 16/46, A61K 51/10, A61P 35/00, G01N 33/574, A61K 39/395</p>	A1	<p>(11) International Publication Number: <b>WO 00/26394</b> (43) International Publication Date: 11 May 2000 (11.05.00)</p>
<p>(21) International Application Number: PCT/US99/25552 (22) International Filing Date: 29 October 1999 (29.10.99) (30) Priority Data: 60/106,534 31 October 1998 (31.10.98) US 60/106,757 2 November 1998 (02.11.98) US (71) Applicant (for all designated States except US): THE GOVERNMENT OF THE UNITED STATES OF AMERICA as represented by THE SECRETARY, DEPARTMENT OF HEALTH AND HUMAN SERVICES [US/US]; Suite 325, 6011 Executive Boulevard, Rockville, MD 20852 (US). (72) Inventors; and (75) Inventors/Applicants (for US only): KASHMIRI, Syed, V., S. [US/US]; 11541 Brandy Hall Lane, Gaithersburg, MD 20878 (US). PADLAN, Eduardo, A. [US/US]; 4006 Simms Drive, Kensington, MD 20895 (US). SCHLOM, Jeffrey [US/US]; 10301 Sorrel Avenue, Potomac, MD 20854 (US). (74) Agent: DAIGNAULT, Ronald, A.; Merchant &amp; Gould P.C., 3100 Norwest Center, 90 South Seventh Street, Minneapolis, MN 55402-4131 (US).</p>	<p>(81) Designated States: AE, AL, AM, AT, AT (Utility model), AU, AZ, BA, BB, BG, BR, BY, CA, CH, CN, CR, CU, CZ, CZ (Utility model), DE, DE (Utility model), DK, DK (Utility model), DM, EE, EE (Utility model), ES, FI, FI (Utility model), GB, GD, GE, GH, GM, HR, HU, ID, IL, IN, IS, JP, KE, KG, KP, KR, KZ, LC, LK, LR, LS, LT, LU, LV, MA, MD, MG, MK, MN, MW, MX, NO, NZ, PL, PT, RO, RU, SD, SE, SG, SI, SK, SK (Utility model), SL, TJ, TM, TR, TT, TZ, UA, UG, US, UZ, VN, YU, ZA, ZW, ARIPO patent (GH, GM, KE, LS, MW, SD, SL, SZ, TZ, UG, ZW), Eurasian patent (AM, AZ, BY, KG, KZ, MD, RU, TJ, TM), European patent (AT, BE, CH, CY, DE, DK, ES, FI, FR, GB, GR, IE, IT, LU, MC, NL, PT, SE), OAPI patent (BF, BJ, CF, CG, CI, CM, GA, GN, GW, ML, MR, NE, SN, TD, TG).</p> <p>Published With international search report. Before the expiration of the time limit for amending the claims and to be republished in the event of the receipt of amendments.</p>	
<p>(54) Title: VARIANTS OF HUMANIZED ANTI-CARCINOMA MONOCLONAL ANTIBODY CC49</p>		
<p>(57) Abstract</p> <p>The invention is directed towards mouse-human chimeric variants of CC49 monoclonal antibodies with minimal murine content. A first aspect of the invention provides CDR variants of humanized monoclonal antibody (HuCC49) in which less than all six (three heavy chain and three light chain) Complementarity Determining Regions (CDRs) of CC49 are present. A second aspect of the invention provides SDR variants of humanized monoclonal antibody (HuCC49) in which only Specificity Determining Regions (SDRs) of at least one CDR from CC49 are present. The invention is also directed towards biotechnological methods of making the variants and therapeutic methods of using the variants.</p>		

BEST AVAILABLE COPY

**FOR THE PURPOSES OF INFORMATION ONLY**

Codes used to identify States party to the PCT on the front pages of pamphlets publishing international applications under the PCT.

AL	Albania	ES	Spain	LS	Lesotho	SI	Slovenia
AM	Armenia	FI	Finland	LT	Lithuania	SK	Slovakia
AT	Austria	FR	France	LU	Luxembourg	SN	Senegal
AU	Australia	GA	Gabon	LV	Latvia	SZ	Swaziland
AZ	Azerbaijan	GB	United Kingdom	MC	Monaco	TD	Chad
BA	Bosnia and Herzegovina	GE	Georgia	MD	Republic of Moldova	TG	Togo
BB	Barbados	GH	Ghana	MG	Madagascar	TJ	Tajikistan
BE	Belgium	GN	Guinea	MK	The former Yugoslav Republic of Macedonia	TM	Turkmenistan
BF	Burkina Faso	GR	Greece	ML	Mali	TR	Turkey
BG	Bulgaria	HU	Hungary	MN	Mongolia	TT	Trinidad and Tobago
BJ	Benin	IE	Ireland	MR	Mauritania	UA	Ukraine
BR	Brazil	IL	Israel	MW	Malawi	UG	Uganda
BY	Belarus	IS	Iceland	MX	Mexico	US	United States of America
CA	Canada	IT	Italy	NE	Niger	UZ	Uzbekistan
CF	Central African Republic	JP	Japan	NL	Netherlands	VN	Viet Nam
CC	Congo	KE	Kenya	NO	Norway	YU	Yugoslavia
CH	Switzerland	KG	Kyrgyzstan	NZ	New Zealand	ZW	Zimbabwe
CI	Côte d'Ivoire	KP	Democratic People's Republic of Korea	PL	Poland		
CM	Cameroon	KR	Republic of Korea	PT	Portugal		
CN	China	KZ	Kazakstan	RO	Romania		
CU	Cuba	LC	Saint Lucia	RU	Russian Federation		
CZ	Czech Republic	LI	Liechtenstein	SD	Sudan		
DE	Germany	LK	Sri Lanka	SE	Sweden		
DK	Denmark	LR	Liberia	SG	Singapore		
ER	Estonia						

VARIANTS OF HUMANIZED ANTI-CARCINOMA  
MONOCLONAL ANTIBODY CC49

**Background**

5           Antibodies are specific immunoglobulin (Ig) polypeptides produced by the vertebrate immune system in response to challenges by foreign proteins, glycoproteins, cells, or other antigenic foreign substances. The binding specificity of such polypeptides to a particular antigen is highly refined, with each antibody being almost exclusively directed to the particular antigen which elicited it. This  
10           specificity resides in the structural complementarity between the antibody combining site and the antigenic determinant. Antibody combining sites are made up of residues that are primarily from the hypervariable or complementarity determining regions (CDRs). Occasionally, residues from nonhypervariable or framework regions do influence the overall domain structure and hence the combining site.

15           There are two major methods for generating vertebrate antibodies: generation of polyclonal antibodies *in situ* by mammalian B lymphocytes and generation of monoclonal antibodies in cell culture by B cell hybrids.

          To generate antibodies *in situ*, an animal (such as a mouse or rabbit) is injected with an antigen. Several weeks later, blood is drawn from the animal and  
20           centrifuged. The resulting serum contains antibodies against the injected antigen. The resulting antibodies are polyclonal antibodies because they are products of many different populations of antibody producing cells and hence differ somewhat in their precise specificity and affinity for the antigen.

          Monoclonal antibodies are produced using hybridoma technology in which  
25           an antibody producing cell is fused with a tumor cell that has the capacity for unlimited proliferation. In contrast to polyclonal antibodies, monoclonal antibodies are homogeneous because they are synthesized by a population of identical cells that are derived from a single hybridoma cell.

          However, the use of monoclonal antibodies in humans is severely restricted  
30           when the monoclonal antibody is produced in a non-human animal. Repeated injections in humans of a "foreign" antibody, such as a mouse antibody, may lead to harmful hypersensitivity reactions, i.e., anti-mouse antibody (HAMA) or an anti-idiotypic, response. The HAMA response makes repeated administrations ineffective due to an increased rate of clearance from the patient's serum and/or  
35           allergic reactions by the patient.

Attempts have been made to manufacture human-derived monoclonal antibodies using human hybridomas. Unfortunately, yields of monoclonal antibodies from human hybridoma cell lines are relatively low compared to mouse hybridomas. Additionally, human cell lines expressing immunoglobulins are relatively unstable compared to mouse cell lines, and the antibody producing capability of these human cell lines is transient. Thus, while human immunoglobulins are highly desirable, human hybridoma techniques have not yet reached the stage where human monoclonal antibodies with the required antigenic specificities can be easily obtained.

Thus, antibodies of non-human origin have been genetically engineered to create chimeric or humanized antibodies. Such genetic engineering results in antibodies with a reduced risk of a HAMA response compared to that expected after injection of a human patient with a mouse antibody. For example, chimeric antibodies can be formed by grafting non-human variable regions to human constant regions. Khazaeli et al. (1991), *J. Immunotherapy* 15:42-52. Generally humanized antibodies, are formed by grafting non-human complementarity determining regions (CDRs) onto human framework regions (FRs) (See European Patent Application 0 239 400; Jones et al. (1986), *Nature (London)*, 321:522-525; and Reichman et al. (1988), *Nature (London)*, 332:323-327). Typically, humanized monoclonal antibodies are formed by grafting all six (three light chain and three heavy chain) CDRs from a non-human antibody into Framework Regions (FRs) of a human antibody. Alternately, Fv antibodies (See United States Patent 4,642,334) or single chain Fv (SCFV) antibodies (See United States Patent 4,946,778) can be employed to reduce the risk of a HAMA response.

However, these modified antibodies still retain various non-human light and heavy chain variable regions: the chimeric, Fv and single chain Fv antibodies retain entire non-human variable regions and CDR-grafted antibodies retain CDR of non-human origin. Such non-human regions can elicit an immunogenic reaction when administered to a human patient. Thus, many humanized MAbs remain immunogenic in both subhuman primates and in humans, with the humoral response of the host directed towards the variable region of these MAb (Hakimi et al. (1991), *J. Immunol.*, 147:1352-1359; Stephens et al. (1995), *Immunology*, 85:668-674; Singer et al. (1993), *J. Immunol.*, 150:2844-2857; and Sharkey et al. (1995), *Cancer Res.* 55:5935s-5945s).

One known human carcinoma tumor antigen is tumor associated glycoprotein-72 (TAG-72), as defined by monoclonal antibody B72.3 (See Thor et al., (1986) Cancer Res., 46:3118-3124; and Johnson et al., (1986), Cancer Res., 46:850-85). TAG-72 is associated with the surface of certain tumor cells of human origin.

Numerous murine monoclonal antibodies have been developed which have binding specificity for TAG-72. Exemplary murine monoclonal antibodies include the "CC" (colon cancer) monoclonal antibodies, which are a library of murine monoclonal antibodies developed using TAG-72. Certain CC antibodies have been deposited with the ATCC, including CC49 (ATCC No. HB 9459). Monoclonal antibody (MAb) CC49 is a second-generation antibody of B72.3 that reacts with the pancarcinoma tumor-associated antigen, TAG-72. Radiolabeled MAb CC49 has been shown to target tumor in both animal models and in ongoing radioimmunotherapeutic and radioimmunodiagnostic clinical trials. (Divgi et al. (1994) Nucl. Med. Biol., 21:9-15; Meredith et al. (1994), J. Nucl. Med., 35:1017-1022; Mulligan et al. (1995), Clin. Cancer Res., 1:1447-1454; Arnold et al. (1992), Ann. Surgery, 216:627-632) The potential clinical utility of MAb CC49 is evident both from animal studies and ongoing clinical trials with the antibody. However, patients administered MAb CC49 do generate HAMA responses (Divgi et al. (1994) Nuc. Med. Biol., 21:9-15); Mulligan et al., (1995) Clin. Cancer Res., 1:1447-1454).

A humanized monoclonal antibody (HuCC49) has been formed by grafting hypervariable regions from monoclonal antibody CC49 into variable light (V<sub>L</sub>) and variable heavy (V<sub>H</sub>) frameworks of human monoclonal antibodies LEN and 21/28' CL, respectively, while retaining murine framework residues required for integrity of the antigen combining-site structure. (See, Kashmiri et al., (1995) Hybridoma, 14(5):461-473). This HuCC49 was shown to bind the TAG-72 antigen, albeit with a lower affinity, and demonstrated equivalent tumor targeting in animal models bearing human tumor xenografts.

It has been shown that not all residues of CDRs are critical in the complementarity of antigen/antibody surfaces. Known structures of the antigen-antibody complexes suggests that only 20-33% of CDR residues are involved in antigen contact (Padlan, (1994) Mol. Immunol., 31:169-217). A comprehensive analysis of the available data of the sequences and the three dimensional structure of antibody combining sites has helped identify CDR residues that may be most critical in the antigen antibody interaction (Padlan et al., (1995) FASEB J., 9:133-139).

These residues are designated as specificity determining residues (SDRs).  
Specificity determining residues vary between antibodies.

### **Summary**

5           The invention is directed towards mouse-human chimeric variants of CC49 monoclonal antibodies with minimal murine content which elicit minimal adverse responses when administered to a human patient. The invention is also directed towards biotechnological methods of making the variants and therapeutic methods of using the variants.

10           A first aspect of the invention provides CDR variants of humanized monoclonal antibody (HuCC49) in which less than all six (three heavy chain and three light chain) Complementarity Determining Regions (CDRs) of CC49 are present. A second aspect of the invention provides SDR variants of humanized monoclonal antibody (HuCC49) in which only Specificity Determining Regions  
15 (SDRs) of at least one CDR from CC49 are present. Surprisingly, the CC49 variants of the invention have the same or similar binding affinity as humanized CC49 monoclonal antibody which includes all six (three heavy chain and three light chain) CDRs.

          In particular, the invention relates to variants of HuCC49 in which either L-  
20 CDR1 or L-CDR2, or both, are from a human monoclonal antibody (LEN). These variants of HuCC49 have the substantially the same affinity constant as HuCC49, or show only a two fold lower relative affinity than that of HuCC49.

          Other suitable variants include corresponding human residues at position 97  
of the light chain in addition to a substitution of L-CDR1 and/or L-CDR2 from  
25 CC49 with the corresponding CDRs from a human antibody. In another embodiment, the variant includes a substitution at position 97 on the light chain in addition to a substitution of L-CDR1 and/or L-CDR2 from CC49 with the corresponding CDRs from a human antibody in combination with substitutions at positions 60, 61, 62 and 64 on the heavy chain. In another embodiment, the variant  
30 includes a substitution at position 97 on the light chain in combination with substitutions at positions 60, 61, 62 and 64 on the heavy chain.

**Brief Description of the Figures**

Figure 1 illustrates a basic immunoglobulin structure.

Figure 2 shows a comparison of the CDR sequences of murine MAb CC49 and human MABs LEN and 21/28'CL. Amino acid residues are numbered using the convention of Kabat et al. The underlined numbers indicate the specificity determining residues (SDRs).

Figure 3 is a schematic representation of the eukaryotic expression constructs of the humanized heavy (B) chains of HuCC49. Thin lines represent sequences derived from the prokaryotic vectors pBR322, pBluescript SK<sup>+</sup>, or pCR II. Thick lines depict human  $\gamma$  constant region. Boxes with vertical, horizontal, or cross bars show neomycin, mycophenolic acid, or hygromycin resistance genes; thin arrows show their transcriptional direction. Empty boxes are retroviral long terminal repeats, while thick arrows show the HCMV promoter and its transcriptional direction. Only relevant enzyme sites are shown. A: *Apa*I; B: *Bam*HI; C: *Cla*I; Hd: *Hind*III; Hp: *Hpa*I; N: *Nhe*I; R: *Eco*RI; and S: *Sac*II.

Figure 4 is a schematic representation of the eukaryotic expression constructs of the humanized light chains of HuCC49. As with Figure 3, thin lines represent sequences derived from the prokaryotic vectors pBR322, pBluescript SK<sup>+</sup>, or pCR II. Thick lines depict human  $\kappa$  constant region. Boxes with vertical, horizontal, or cross bars show neomycin, mycophenolic acid, or hygromycin resistance genes; thin arrows show their transcriptional direction. Empty boxes are retroviral long terminal repeats, while thick arrows show the HCMV promoter and its transcriptional direction. Only relevant enzyme sites are shown. A: *Apa*I; B: *Bam*HI; C: *Cla*I; Hd: *Hind*III; Hp: *Hpa*I; N: *Nhe*I; R: *Eco*RI; and S: *Sac*II.

Figure 5 is a schematic representation of the dual expression constructs of the variant heavy (H) and light (L) chain genes derived from the baculovirus vector pAcUW51. P10 and *polh* represent p10 and polyhedrin promoter; arrows show their direction of transcription. Ori and fl are SV40 and fl origin of replication. Amp<sup>R</sup> represents an ampicillin resistant gene.

Figure 6 shows an SDS-PAGE analysis of purified MAb HuCC49 and its variants. All samples are shown in a reduced condition. Lane 1: molecular weight marker (Gibco Brl); Lanes 2-8: variants L-1, L-2, L-3, L-1,2, H-1, H-2 and H-3; Lane 9: HuCC49.

Figure 7 shows an analysis of parental and variant forms of HuCC49 in a competitive RIA. The antigen binding of the light chain (A) and heavy chain (B) CDR variants was assessed using  $^{125}\text{I}$ -labeled HuCC49. In panel A, the competitors were: HuCC49, L-1, L-2, L-3, L-1,2. In panel B, the competitors were: H-1, H-2 and H-3.

Figure 8 shows the effect of light chain CDRs on binding of anti-idiotypic MAbs. The HuCC49 CDR variants were characterized in a competition RIA with  $^{125}\text{I}$ -HuCC49 and CC49 anti-idiotypic MAbs AI49-3 (panel A), AI49-1 (panel B) and AI49-8 (panel C). The competitors were: HuCC49, L-1, L-2, L-3, L-1,2.

Figure 9 shows the effect of heavy chain CDRs on binding of anti-idiotypic MAbs. The HuCC49 CDR variants were characterized in a competition RIA with  $^{125}\text{I}$ -CC49 and CC49 anti-idiotypic MAbs AI49-3 (panel A), AI49-1 (panel B) and AI49-8 (panel C). The competitors were: HuCC49, H-1, H-2, H-3.

Figure 10 shows an analysis of human anti-idiotypic antibodies to HuCC49 variants using a competitive RIA by HPLC methodology. A patient's anti-idiotypic response to CC49 was characterized using purified parental HuCC49 and CDR variants as competitors with  $^{125}\text{I}$ -HuCC49. The inability of a variant to inhibit complex formation of the patient's sera with the  $^{125}\text{I}$ -HuCC49 indicates that the CDR replaced from the variant was immunogenic to the patient. In panel A, the competitors were: HuCC49, L-1, L-2, L-3, L-1,2. In panel B, the competitors were: H-1, H-2 and H-3.

Figure 11 shows the amino acid sequences of  $V_L$  frameworks of human MAb LEN and humanized  $V_L$  of CC49 (HuCC49) in panel A. Panel B shows the amino acid sequences of  $V_H$  frameworks of human MAb 21/28'CL and humanized  $V_H$  of CC49 (HuCC49). Framework residues that are deemed to be important in maintaining the combining site structure of CC49 are marked by an asterisk.

Figure 12 shows the nucleotide sequence of HuCC49 variable light ( $V_L$ ) and variable heavy ( $V_H$ ) region genes in panels A and B, respectively. Sequences of flanking oligomers that do not encode the variable region domains or their leader peptides are shown in lowercase letters. The  $V_L$  region (A) is encoded by nucleotides from positions 74 to 412, while nucleotides from position 70 to 415 (B) comprise the  $V_H$  region.

Figure 13 is a graph of the results of a competition assay using variants of HuCC49.



Figure 14 shows the results of an HPLC analysis of patient reactivity to variants of HuCC49. Competitors were at 5µg per reaction. The values are the percent of complexes, the higher molecular weight species, resolved by size-exclusion chromatography. Complex formation indicates removal of the epitope recognized by the patient's antibody. Inhibition of complex formation indicates that the immunogenic epitope is still present in the HuCC49 variant.

Figure 15 is a graph showing the comparison of patient reactivity with HuCC49 and various variants thereof.

Figure 16 is graph showing the immunoreactivity of variant  $^{97}\text{L}_{1,2}/^{60-62,64}\text{H}$ .

Figure 17 is a graph of the pharmacokinetics of plasma retention of HuCC49 and a variant thereof.

Figure 18 is a table showing the biodistribution of i.v. administered radiolabeled HuCC49 and variants in athymic mice bearing LS-174T human colon carcinoma xenografts. Athymic mice bearing LS-174T human colon carcinoma xenografts (s.c.) were coinjected with 1.4µCi of  $^{131}\text{I}$ -HuCC49 and 4.4 of  $^{125}\text{I}$ -Variant. The mice were sacrificed at the timepoints indicated, the organs harvested, wet-weighted and the radioactivity detected in a  $\gamma$ -scintillation counter. The percent weight injected dose per gram for each tissue was calculated. The standard error of the mean was also calculated and were 0.06%ID/g or less.

Figure 19. HPLC analysis of patient HAMA following intravenous injection of  $^{177}\text{Lu}$ -CC49.

Figure 20. HPLC analysis of patients' humoral response to the variable region of MAb CC49. The percent complex formation has been plotted versus time for (solid lines) patients DS (O), LW (□), JJ (Δ), DG (●), LJ (■), TD (▲); (dotted lines) JG (O), RW (□), JM (Δ), EA (●), CP (■), LQ (▲);

Figure 21. Detection of patient anti-idiotypic antibody response to murine CC49.

Figure 22. HPLC analysis demonstrating CDR specificity of patient LQ.

### 30 Definitions

Prior to setting forth the invention, definitions of certain terms which are used in this disclosure are set forth below:

Antibody: This refers to single chain, two-chain, and multi-chain proteins and glycoproteins belonging to the classes of polyclonal, monoclonal, chimeric and hetero immunoglobulins (monoclonal antibodies being preferred); it also includes

synthetic and genetically engineered variants of these immunoglobulins. "Antibody fragment" includes Fab, Fab', F(ab')<sub>2</sub>, and Fv fragments, as well as any portion of an antibody having specificity toward a desired target epitope or epitopes.

5 Chimeric antibody: This refers to an antibody which includes sequences derived from two different antibodies, which typically are of different species. Most typically, chimeric antibodies include human and murine antibody fragments, generally human constant and murine variable regions.

10 Humanized antibody: This refers to an antibody derived from a non-human antibody, typically murine, and a human antibody which retains or substantially retains the antigen-binding properties of the parent antibody but which is less immunogenic in humans.

15 Complementarity Determining Region, or CDR: This refers to amino acid sequences which together define the binding affinity and specificity of the natural Fv region of a native immunoglobulin binding site. The light and heavy chains of an immunoglobulin each have three CDRs, designated L-CDR1, L-CDR2, L-CDR3 and H-CDR1, H-CDR2, H-CDR3, respectively. By definition, the CDRs of the light chain are bounded by the residues at positions 24 and 34 (L-CDR1), 50 and 56 (L-CDR2), 89 and 97 (L-CDR3); the CDRs of the heavy chain are bounded by the residues at positions 31 and 35b (H-CDR1), 50 and 65 (H-CDR2), 95 and 102 (H-CDR3), using the numbering convention delineated by Kabat et al., (1991)

20 Sequences of Proteins of Immunological Interest, 5th Edition, Department of Health and Human Services, Public Health Service, National Institutes of Health, Bethesda (NIH Publication No. 91-3242).

25 Framework Region: This refers to amino acid sequences interposed between CDRs. These portions of the antibody serve to hold the CDRs in an appropriate orientation for antigen binding.

Specificity Determining Residue, or SDR: This refers to amino acid residues of an immunoglobulin that are directly involved in antigen contact.

30 Constant Region: This refers to the portion of the antibody molecule which confers effector functions. In the present invention, the variant antibodies include constant regions derived from human immunoglobulins. The heavy chain constant region can be selected from any of five isotypes: alpha, delta, epsilon, gamma or mu. Heavy chains of various subclasses (such as the IgG subclass of heavy chains) are responsible for different effector functions. Thus, by choosing the desired heavy chain constant region, humanized antibodies with the desired effector function can

35

be produced. The light chain constant region can be of the kappa or lambda type, preferably the kappa type.

**Mammals:** This refers to animals that nourish their young with milk secreted by mammary glands, preferably warm blooded mammals.

5 **Immunogenicity:** A measure of the ability of a targeting protein or therapeutic moiety to elicit an immune response (humoral or cellular) when administered to a recipient. The present invention is concerned with the immunogenicity of humanized antibody CC49.

10 **Reduced immunogenicity:** This refers to an antibody, typically humanized, that exhibits reduced immunogenicity relative to the parent antibody.

**Immunoreactivity:** A measure of the ability of an immunoglobulin to recognize and bind to a specific antigen.

15 **Substantially similar binding properties:** This refers to a humanized antibody which retains the ability to specifically bind the antigen recognized by the parent antibody used to produce the humanized antibody. Preferably, the affinity of the humanized antibody is at least about 10% of the affinity of the parent antibody, more preferably at least about 25%, even more preferably at least about 50%. Most preferably, the humanized antibody exhibits antigen-binding affinity that is at least about 75% of the affinity of the parent antibody. Methods for assaying antigen-binding affinity are well known in the art and include half-maximal binding assays, competition assays, and Scatchard analysis.

20 **Substantially Homologous:** Refers to immunoglobulin sequences that exhibit at least about 85% identity, more preferably about 90% identity, most preferably about 95% identity with a reference immunoglobulin, wherein % identity is determined by comparing the number identical of amino acid residues between the two immunoglobulins, wherein the positions of the amino acid residues are indicated using the Kabat numbering scheme.

25 **Nomenclature:** Nucleic acids, amino acids, peptides, protective groups, active groups and so on, when abbreviated, are abbreviated according to the IUPAC IUB (Commission on Biological Nomenclature) or the practice in the fields concerned.

### **Detailed Description**

35 To facilitate understanding of the invention, a discussion of the structure of a typical antibody molecule will first be provided. The basic immunological structural

unit is shown in Figure 1. Antibodies (also referred to as immunoglobulins) are constructed from four polypeptide chains, two heavy chains and two light chains. The two heavy chains are linked to each other by disulfide bonds and each heavy chain is linked to a light chain by a disulfide bond. There are two types of light chain, lambda ( $\lambda$ ) and kappa ( $\kappa$ ). There are five main heavy chain classes (or isotypes) which determine the functional activity of an antibody molecule: IgM, IgD, IgG, IgA and IgE.

Each chain contains distinct sequence domains. The light chain includes two domains, a variable domain ( $V_L$ ) and a constant domain ( $C_L$ ). The heavy chain includes four domains, a variable domain ( $V_H$ ) and three constant domains ( $C_{H1}$ ,  $C_{H2}$  and  $C_{H3}$ , collectively referred to as  $C_H$ ). The variable regions of both light ( $V_L$ ) and heavy ( $V_H$ ) chains determine binding recognition and specificity to the antigen. The constant region domains of the light ( $C_L$ ) and heavy ( $C_H$ ) chains confer important biological properties such as antibody chain association, secretion, transplacental mobility, complement binding, and binding to Fc receptors. The Fv fragment is the N-terminal part of the Fab fragment of an immunoglobulin consisting of the variable portions of one light chain and one heavy chain. The specificity of the antibody resides in the structural complementarity between the antibody combining site and the antigenic determinant. Antibody combining sites are made up of residues that are primarily from the hypervariable or complementarity determining regions (CDRs). Occasionally, residues from nonhypervariable or framework regions (FR) influence the overall domain structure and hence the combining site.

The variants of the invention are derived from a humanized CC49 (referred to as "parental HuCC49"). Parental HuCC49 is formed by grafting all six (three heavy chain and three light chain) MAb CC49 hypervariable regions onto the variable light ( $V_L$ ) and variable heavy ( $V_H$ ) frameworks of the human MAbs LEN and 21/28<sup>CL</sup>, respectively, while retaining murine framework residues that may be required for the integrity of the antigen combining site structure (Figure 11). (Kashmiri et al., (1995) *Hybridoma*, 14:461-473). The variants of the invention contain a reduced murine content, and consequently, reduced immunogenicity, when compared to HuCC49. Nonetheless, the variants of the invention retain a binding affinity that is substantially similar to that of HuCC49. Preferably the binding affinity is at least about  $10^8 M^{-1}$ . As used herein, HuCC49 refers to the humanized

antibody formed by Kashmiri et al. The terms "variant HuCC49" or "variant" refer to the immunoglobulins of the invention.

A first aspect of the invention provides CDR variants of humanized monoclonal antibody (HuCC49) in which less than all six (three heavy chain and three light chain) Complementarity Determining Regions (CDRs) of CC49 are present. A second aspect of the invention provides SDR variants of humanized monoclonal antibody (HuCC49) in which only Specificity Determining Regions (SDRs) of at least one CDR from CC49 are present.

#### CDR Variants

According to the invention, CDR variants are formed by replacing at least one CDR of CC49 in HuCC49 with a corresponding CDR from a human antibody. Preferably, the L-CDR1 or L-CDR2, or both, from CC49 are replaced by a corresponding CDR from a human antibody. The inventors have found that a variant in which any of L-CDR3, H-CDR1, H-CDR2 or H-CDR3 of CC49 are replaced by a corresponding CDR from a human antibody do not retain significant binding affinity.

#### Binding Affinity of CDR Variants

According to the invention, CDR variants in which L-CDR1 or L-CDR2 of CC49, or both, are replaced by a corresponding CDR from a human antibody retain biological activity that is substantially similar to the binding affinity of the parental CC49. Generally, the CDR variants of the invention have a binding affinity that is about 25% to about 50% if the binding affinity of the parental CC49, more preferably about 50% to about 75%, most preferably, about 75% to about 100%.

CDR variants in which H-CDR2 is replaced by a corresponding CDR from a human antibody that is only slightly immunoreactive with TAG-72. In particular, such variants have a relative binding affinity that is about 300 fold less than that of CC49.

CDR variants in which L-CDR3, H-CDR1, or H-CDR3 are replaced by a corresponding CDR from a human antibody do not appear to retain any binding affinity for TAG-72.

Immunogenicity of CDR Variants

The CDR variants that have a reduced immunogenicity when compared to HuCC49 formed by grafting all six (three heavy chain and three light chain) CDR from CC49 onto the variable light (V<sub>L</sub>) and variable heavy (V<sub>H</sub>) frameworks of the human MAb

5 human MAb LEN and 21/28'CL, respectively. That is, the CDR variants of the invention are less likely to elicit an anti-idiotypic or HAMA response.

Immunogenicity can be characterized using competition radioimmunoassays known in the art in which an "anti-CC49" antibody that recognizes the parental CC49 is exposed to both the parental MAb and the variant. Generally, a reduction in

10 immunogenicity is reflected by a reduction in binding of the variant by the anti-CC49 antibody.

CDR variants in which L-CDR1 or L-CDR2, or both, of CC49 are replaced by a corresponding CDR from a human antibody show a slight reduction in immunogenicity, that is, the variants do not bind to the anti-CC49 antibody as well

15 as HuCC49.

CDR variants in which L-CDR3 or H-CDR2 of CC49, is replaced by a corresponding CDR from a human antibody show a substantial reduction in immunogenicity. However, the inventors have found that such variants also show a substantial reduction in immunoreactivity.

CDR variants in which H-CDR1 or H-CDR3 or CC49 are replaced by a corresponding CDR from a human antibody do not show any measurable change in immunogenicity.

20

SDR Variants

The inventors have discovered that all six CDR of CC49 need not be present in their entirety for the humanized antibody to retain activity. Only residues that are directly involved in antigen contact, the Specificity Determining Residues (SDRs), are needed. SDR variants are formed by replacing at least one SDR of CC49 in HuCC49 with a residue at a corresponding position from a human antibody.

25

It should be noted that not all CDRs include SDRs. For example, it was determined that L-CDR1 and L-CDR2 of CC49 do not have any SDRs. Therefore, in one variant of the invention, L-CDR1 and L-CDR2 are replaced entirely with human CDRs. However, SDR variants can be formed by replacing residues within these CDRs with a corresponding human residue. L-CDR1 from CC49 and LEN

30

35 differ at three positions, 27b, 27f and 29. Because residues 27b, 27f, 29 are not

important for the binding affinity of CC49, a suitable SDR variant can include a corresponding human residue at any of these position, or at any combination of these positions. L-CDR2 from CC49 and LEN differ at position 53 only. Residue 53 is not considered important for the binding affinity of CC49. Thus, a suitable variant can include a corresponding human residue at position 53.

L-CDR3 of CC49 differs from LEN at three positions, 94, 96 and 97. The partially buried residue at position 97 is not important for the antigen binding activity of CC49. Thus, a suitable SDR variant can include a corresponding human residue at position 97. However, positions 94 and 96 of L-CDR3 are involved in ligand contact. and should not be replaced to generate a functional SDR variant.

H-CDR1 of CC49 and 21/28'CL differ at three positions, 31, 32 and 34. However, SDR variants which include a corresponding human residue at positions 32 and 24 demonstrate no antigen binding affinity. Thus, a functional SDR variant should not include a corresponding human residue at either of these positions.

H-CDR2 of CC49 differs from human MA b 21/28'CL at eleven positions. The residues at positions 60, 61, 62 and 64 are not required for antigen binding activity. Therefore, a SDR variant of the invention can include a corresponding human residue at any of positions 60, 61, 62 and 64, or any combinations thereof.

Generally, H-CDR3 does not need to be considered when designing an SDR variant, because it does not show any reactivity to patients' sera.

In a preferred embodiment, the variant includes a combination of CDR and/or SDR substitutions to generate a variant having reduced immunogenicity and a binding affinity that is substantially similar to that of parental CC49. Suitable combinations include CDR variants in which both L-CDR1 and L-CDR2 of CC49 are replaced by a corresponding CDR from a human antibody. Other suitable variants include a combination of SDR and CDR substitutions. For example, a suitable variant can include corresponding human residues at position 97 of the light chain in addition to a substitution of L-CDR1 and/or L-CDR2 from CC49 with the corresponding CDRs from a human antibody. In another preferred embodiment, the variant includes a substitution at position 97 on the light chain in combination with substitutions at positions 60, 61, 62 and 64 on the heavy chain. In yet another embodiment, the variant includes a substitution at position 97 on the light chain in addition to a substitution of L-CDR1 and/or L-CDR2 from CC49 with the corresponding CDRs from a human antibody in combination with substitutions at positions 60, 61, 62 and 64 on the heavy chain.

In addition to variants specifically described herein, other "substantially homologous" modified immunoglobulins can be readily designed and manufactured using various recombinant DNA techniques well known to those skilled in the art. For example, the framework regions can be varied at the primary structure level.

5 Moreover, a variety of different human framework regions may be used singly or in combination as a basis for the variant. In general, modifications of the genes may be readily accomplished by a variety of well-known techniques, such as site-directed mutagenesis.

10 Alternatively, polypeptide fragments comprising only a portion of the primary antibody structure may be produced wherein the fragment substantially retains the immunoreactive properties of the variant. These polypeptide fragments include fragments produced by proteolytic cleavage of intact antibodies by methods well known in the art, or fragments produced by inserting stop codons at the desired locations nucleotide sequence using site-directed mutagenesis. For example, a stop  
15 codon can be inserted after C<sub>H</sub>1 to produce Fab fragments or after the hinge region to produce F(ab')<sub>2</sub> fragments. Single chain antibodies and fusion proteins which includes at least an immunoreactive fragment of the variant are also included within the scope of the invention. For example, the variants may be directly or indirectly attached to effector moieties having therapeutic activity. Suitable effector moieties  
20 include cytokines, cytotoxins, radionuclides, drugs, immunomodulators, therapeutic enzymes, anti-proliferative agents, etc. Methods for attaching antibodies to such effectors are well known in the art.

#### Binding Affinity of SDR Variants

25 L-CDR1 from CC49 and LEN differ at three positions, 27b, 27f and 29. Since L-CDR1 of CC49 can be replaced with the corresponding CDR from LEN without any significant loss of antigen binding reactivity, residues 27b, 27f, 29 are not considered important for the binding affinity of CC49. Thus, a variant of the invention can include a corresponding human residue at any of these three positions,  
30 or any combination thereof, and retain a binding affinity that is substantially similar to that of the parent HuCC49.

In L-CDR2, CC49 and LEN differ at position 53 only. Since L-CDR2 of CC49 can be replaced with the corresponding CDR from LEN without any significant loss of antigen binding reactivity, residue 53 is not considered important  
35 for the binding affinity of CC49. Thus, the humanized antibody of the invention



can include a corresponding human residue at residue 53 and retain a binding affinity that is substantially similar to that of the parent HuCC49.

5 L-CDR3 of CC49 differs from LEN at three positions, 94, 96 and 97. The partially buried residue at position 97 is not important for the antigen binding activity of CC49. Thus, the humanized antibody of the invention can include a corresponding human residue at position 97 and retain a relative binding affinity that is substantially similar to that of CC49. However, positions 94 and 96 of L-CDR3 appear to be involved in ligand contact. Therefore, an SDR variant which includes a corresponding human residue at either position 94 or 96, or both will generally  
10 suffer total or near total loss of antigen binding reactivity.

H-CDR1 of CC49 and 21/28'CL differ at three positions, 31, 32 and 34. SDR variants which include a corresponding human residues at positions 32 and 24 demonstrate no antigen binding affinity.

H-CDR2 of CC49 differs from human MAb 21/28'CL at eleven positions.  
15 The residues at positions 60, 61, 62 and 64 do not appear to be required for antigen binding activity. Therefore the humanized antibody of the invention can include a corresponding human residue at any of positions 60, 61, 62 and 64, or any combinations thereof, and the variant will retain a binding affinity that is substantially similar to that of CC49.

20

#### Immunogenicity of SDR Variants

SDR variants are particularly beneficial because some CDRs that are important for immunoreactivity are also immunogenic (e.g., L-CDR3 and H-CDR2). Thus, the immunogenicity of various SDR replacements within L-CDR3  
25 and H-CDR2 were examined.

As shown in Figure 2, L-CDR3 consists of residues 89-97 and H-CDR2 consists of residues 50-65. The inventors have found that SDR variants which include a corresponding human residue in positions 32 and 34 (found within H-CDR1) or at position 97 (found within L-CDR3) are still immunogenic. Whereas,  
30 SDR variants which include a corresponding human residue in positions 60, 61, 62, and 64 (found within H-CDR2) or at position 94 (found within L-CDR3) show a reduction in immunogenicity. SDR variants which include a corresponding human residue in position 96 (found within L-CDR3) do not appear to be immunogenic.

Generally, the residues found in H-CDR3 does not need to be considered when designing SDR variants, because it does not show any reactivity to patients' sera.

5            Human Antibodies

Suitable human antibodies include, but are not limited to: ROY, AU, REI, HAU, HK101'CL, SCW, WEA, HK137'CL, HK134'CL, DAUDI'CL, WALKER'CL, GAL(1), LAY, WES, Vb'CL, HK102'CL, EU, DEN, AMYLOID BAN, MEV, Vd'CL, Va'CL, KUE, Ve'CL, V13'CL, V18A'CL, V19A'CL, V19B'CL, V18C'CL, 10 NIM, CUM, GM603CL, FR, RP M1-6410'CL, TI, WOL, SIE, NG9'CL, NEU, GOT, PAY, SON. GAR', PIE, FLO, GLO, CUR, IARC/BL41'CL, POM, REE, K-EV15'CL, VJ'CL, VKAPPAIV, GERMLINE'CL, PB171'CL, LEN, NEWM, HA, NIG-64, NEW, BL2'CL, WAH, NIG-77, VOR, RHE, LOC,OKA, COX, NIG-51, NIG-84, MES, WH, NEI, WEIR, TOG, TRO, BOH, NIG-58, VIL, WIN, 41'CL, 15 HIL, LAP, GAR, MOT, BO, MDG, AMYLOID-AR, SUT, THO, LBV'CL, NIG-48, HG3'CL, ND'CL, COR, DAW, OU, MCE', CE-1'CL, HE, SUP-T1, VH-JA'CL, HIG1'CL, TUR, LAMDA-VH26'CL, WAS, H11'CL, TEI, BRO'IGM, GRA', ZAP, JON, DOB, NIE, 333'CL, 1H1'CL, 1B11'CL, 126'CL, 112'CL, 115'CL, KOL and 21/28'CL. New human antibodies are being discovered and sequenced, many of 20 those, as of yet unknown antibodies may also be suitable. Preferably, human antibody has a sequence that is identical or substantially similar (containing as few mutations as possible) to the human germ line sequences. For example, the light chain CDR of CC49 in HuCC49 can be replaced with the corresponding CDR from LEN (Kabat et al., 1991) and the heavy chain CDR can be replaced with the 25 corresponding CDR from 21/28'CL (Kabat et al., 1991).

Methods of Producing

The variants of the invention can be produced by expressing the appropriate DNA sequence in a host after the sequence has been operably linked to (i.e., 30 positioned to ensure the functioning of) an expression control sequence. Such expression vectors are typically replicable in a host organism either as episomes or as an integral part of the host chromosomal DNA. The expression vectors typically contain expression control sequences compatible with the host cell, such as an origin of replication. In addition, the expression vector will typically include a promoter. 35 Suitable promoters include the polyhedrin promoter, lactose promoter system, a

tryptophan promoter system, a beta-lactamase promoter system, or a promoter system from phage lambda. Promoters typically control expression of the gene, optionally, with operator sequences, and have ribosome binding site sequences and the like for initiating and completing transcription and translation. Commonly, expression vectors will contain selection markers. DNA sequences encoding the light chain and heavy chain of the antibody may be inserted into separate expression vectors, or into the same expression vector.

Suitable hosts include prokaryotic strains such as *E. coli*; *Bacilli*, including *Bacillus subtilis*; enterobacteriaceae, including *Salmonella*, *Serratia* and *Psuedomonas*. Suitable hosts also include eukaryotic hosts such as yeast, including *Saccharomyces*; *Pichia pastoris*; Sf9 insect cells; Sp2/0, VERO and HeLa cells, Chinese hamster ovary (CHO) cell lines; W138, BHK, COS-7 and MDCK cell lines.

The vectors containing the DNA segments of interest can be transferred into the host cell by well-known methods, which vary depending on the type of cellular host. For example, calcium chloride transfection, calcium phosphate treatment, electroporation or cationic liposome mediated transfection (such as DOTAP). Successfully transformed cells, can be identified by a variety of techniques well known in the art for detecting the binding of a receptor to a ligand.

Once expressed, the gene products can be purified according to standard procedures of the art, including ammonium sulfate precipitation, affinity columns, column chromatography, and gel electrophoresis. Substantially pure immunoglobulins of at least about 90% to about 95% homogeneity are preferred, and 98% to 99% or more homogeneity most preferred for pharmaceutical uses.

#### Methods of Use

Once purified, the variants of the invention may be used therapeutically, or in developing and performing assays, *in vivo* or *in vitro* diagnostic procedures, and imaging. The variants of the invention are particularly useful for the treatment of diseases such as cancer, in particular for treating or detecting cancer. The variants can be administered to a patient alone or in combination with a pharmaceutical formulation. Typically, the variants are incorporated into a pharmaceutically acceptable, non-toxic, sterile carrier as a suspension or solution. The antibodies of the invention can be used as separately administered compositions or given in conjunction with chemotherapeutic or immunosuppressive agents.

The variants provide unique benefits when used for the treatment of cancer. In addition to the ability to bind specifically to malignant cells and localize tumors without binding to non-cancerous cells, the variants have a reduced immunogenicity when compared to HuCC49.

5 For diagnostic purposes, the antibodies may either be labeled or unlabeled. Unlabeled antibodies can be used in combination with other labeled antibodies (second antibodies) that are reactive with the humanized antibody, such as antibodies specific for human immunoglobulin constant regions. Alternatively, the antibodies can be directly labeled. A wide variety of labels can be employed, such  
10 as radionuclides, fluors, enzymes, enzyme substrates, enzyme cofactors, enzyme inhibitors, ligands (particularly haptens), etc. Numerous types of immunoassays are available and are well known to those of skill in the art.

Kits according to the present invention include frozen or lyophilized variant to be reconstituted by thawing or by suspension in a liquid vehicle. The kits may  
15 also include a carrier or buffer. Preferably, the kit also comprises instructions for reconstituting and using the variant antibody.

#### **Working Examples**

To identify the CDRs essential for binding, a panel of variant HuCC49 MAbs  
20 were generated using the baculovirus expression system. HuCC49 was prepared by grafting MAb CC49 CDRs onto the V<sub>L</sub> and V<sub>H</sub> frameworks of the human MAbs LEN and 21/28' CL, respectively, as described by Kashmiri et al., (1995) Hybridoma, 14:461-473. Six CDR variants were constructed by replacing a single CC49 CDR of either the light or heavy chain with the corresponding human  
25 antibody CDR (LEN and 21/28'CL, respectively). Variants were denoted as L-1, L-2, L-3, H-1, H-2 or H-3. A seventh variant, L-1,2 was made by replacing two CC49 light chain CDRs (L-CDR1 and L-CDR2) with the corresponding CDRs of the human antibody LEN.

Since the seven CDR variants were derived by simply replacing the murine  
30 CDRs with the human antibody hypervariable regions, all of the variants carry identical V<sub>H</sub> and V<sub>L</sub> frameworks and  $\gamma$ 1 and k chain constant regions

SDR heavy chain and light variants were constructed by substituting mutagenic nucleotides in or near the CDRs.

**Example I: Preparation of CDR Substituted MAb CC49**

According to the invention, CDR variants are formed by replacing at least one CDR of CC49 in HuCC49 with a corresponding CDR from a human antibody.

5 The CDR variants of the invention include:

- Variant L-1: L-CDR1 of CC49 was replaced with that of LEN.
- Variant L-2: L-CDR2 of CC49 was replaced with that of LEN.
- Variant L-3: L-CDR3 of CC49 was replaced with that of LEN.
- Variant L-1,2: L-CDR1 and L-CDR2 of CC49 were replaced with that of LEN.
- 10 • Variant H-1: H-CDR1 of CC49 was replaced with that of 21/28'CL.
- Variant H-2: H-CDR2 of CC49 was replaced with that of 21/28'CL.
- Variant H-3: H-CDR3 of CC49 was replaced with that of 21/28'CL.

*Production of Oligomers to generate V<sub>H</sub> Variants*

15 Synthesis of three variant V<sub>H</sub> genes was performed using the overlap extension PCR technique described by Kashmiri et al., (1995) Hybridoma 14:461-473. Four 124-137 base pair long overlapping oligonucleotides, (which together encompass the entire sequence of the variant V<sub>H</sub> gene on alternating strands) were used to generate variant V<sub>H</sub> genes. (Figure 12 B) The oligomers were supplied by  
20 Midland Certified Reagent Co., Midland, TX. Instead of a template DNA, the PCR mixture contained 2 pmoles of the four oligonucleotides. PCR was carried out by three cycles of a denaturing step at 94°C for 1 minute, a primer annealing step at 55°C for 2 minutes, and an extension step at 70°C for 2 minutes, followed by 17  
25 additional cycles of denaturation (94°C, 1 minute), primer annealing (55°C, 2 minutes), and extension (72°C, 1 minute). All polymerase chain reactions (PCRs) were carried out in a final volume of 100 µl of PCR buffer containing 100 µM of dNTPs, 5 units of Taq DNA polymerase (Boehringer Mannheim) and 20 pmol of each end primer.

30 *Production of Oligomers to Generate V<sub>L</sub> Variants*

The three variant V<sub>L</sub> genes were generated using 30-43 base oligonucleotides as a mutagenic primer. The oligonucleotides contained the desired base changes in the targeted CDR. The mutagenic primers for the V<sub>L</sub> genes were synthesized using a Model 8700 DNA synthesizer (Miligen/Bioresearch, Burlington,  
35 VT). (Figure 12 A) Primer induced mutagenesis was carried out by a two-step PCR

method, as described by Landt et al., (1990) *Gene*, 96:125–128.

pLNXC<sub>Hu</sub>CC49<sub>Hu</sub>K (Kashmiri et al., (1995) *Hybridoma* 14:461–473) (Figure 2) was used as a template in both steps. In the first step, the mutagenic primer was used as a 3' primer while a 20 nucleotide long end primer served as a 5' primer. The product of the first PCR was gel purified and utilized as a 5' primer for the second PCR in which a 20 nucleotide long end primer was used as a 3' primer. The 20 nucleotide long end primers used for DNA amplification were supplied by Midland Certified Reagent Co. (Midland, TX). The sequences for these primers are reported by Kashmiri et al., (1995) *Hybridoma* 14:461–473 and are as follows:

1. 5' V<sub>H</sub>, 5'-CTA AGC TTC CAC CAT GGA G-3'
2. 3' V<sub>H</sub>, 5'-ATG GGC CCG TAG TTT GGC G-3'
3. 5' V<sub>L</sub>, 5'-GCA AGC TTC CAC CAT GGA TA-3'
4. 3' V<sub>L</sub>, 5'-AGC CGC GGC CCG TTT CAG TT-3'

Each of the primers carries a single restriction endonuclease site at its flank. The 5' primers carry a *Hind*III site, while the 3' V<sub>H</sub> primer carries an *Apa*I, and the 3' V<sub>L</sub> primer has a *Sac*II site. The restriction endonuclease recognition sequences are underlined.

The first PCR was carried out in a final volume of 100 µl containing 10 ng of the template DNA, 20 pmol each of the 3' and 5' primers, 100 µM dNTPs and 5 units of Taq DNA polymerase (Boehringer Mannheim, Indianapolis, IN). Each step of the PCR consisted of 25 cycles of denaturation (94°C, 1 minute), primer annealing (45°C, 2 minutes), and extension (72°C, 2 minutes). The PCR product was extracted with phenol/chloroform, precipitated with ethanol and gel purified prior to insertion into a vector.

#### Example II. Assembly of CDR Substituted MAb CC49 PCR Products

The PCR products encoding the V<sub>H</sub> were treated with *Hind*III/*Apa*I. The PCR products were subcloned for sequencing in pBluescript S/K+ (Stratagene, La Jolla, CA) at a *Hind*III/*Apa*I site after the plasmid was linearized using the appropriate restriction endonucleases. Inserts were sequenced to check their fidelity to their templates.

To assemble the variable and constant regions of the heavy chain the *Hind*III/*Apa*I insert was released from pBluescript. A DNA fragment encoding the human γ1 constant region was excised from pLgpCX<sub>Hu</sub>CC49<sub>Hu</sub>G1 (Kashmiri et al,

(1995) *Hybridoma* 14:461–473), (Figure 3) by *ApaI/ClaI* cleavage. The *HindIII/ApaI* and the *ApaI/ClaI* fragments were joined. The recombinant was unidirectionally inserted, by three way ligation, between the *HindIII* and *ClaI* sites of pBluescript. The DNA sequence encoding the entire heavy chain was then  
5 cleaved from pBluescript by *HindIII/ClaI* digestion. Its termini were filled in using the Klenow fragment of the DNA polymerase. The insert was subcloned in a light chain construct of pAcUW51 (Figure 4), at the blunt ended *BamHI* site located downstream of the polyhedrin promoter.

The PCR products encoding the  $V_L$  were treated with *HindIII/SacII*. The  
10 PCR products were subcloned for sequencing in pBluescript S/K+ (Stratagene, La Jolla, CA) at a *HindIII/SacII* site after the plasmid was linearized using the appropriate restriction endonucleases. Inserts were sequenced to check their fidelity to their templates.

To assemble the variable and constant region of the light chain, the  
15 *HindIII/SacII* insert was released from the pBluescript construct. A DNA fragment encoding the human kappa constant region was excised from pLNCXHuCC49HuK (Kashmiri et al, (1995) *Hybridoma* 14:461–473), (Figure 2) by *SacII/ClaI* treatment. The *HindIII/SacI* fragments were joined to the *HindIII/ClaI* linearized pBluescript by three way ligation. The entire light chain was cleaved from pBluescript using  
20 *EcoRI*. The *EcoRI* fragment was inserted into the baculovirus expression vector pAcUW51 (PharMingen, San Diego, CA) at the *EcoRI* site located downstream from the p10 promoter.

The baculovirus expression construct of the parental HuCC49 was generated using DNA fragments encoding HuCC49 heavy and light chains obtained from  
25 PLNCXHuCC49HuK and pLgpCXHuCC49HuG1. PLNCXHuCC49HuK was cleaved with *HindIII*. The resulting ~1.0 Kb DNA fragment encoding HuCC49HuK was subcloned in pBluescript at the *HindIII* site. The resulting construct was then cleaved with *BamHI* and the fragment was cloned in the baculovirus vector pAcUW51 at the *BamHI* site, downstream from the polyhedrin promoter. A ~1.4  
30 Kb DNA fragment encoding HuCC49HuG1 was cloned from pLgpCXHuCC49HuG1 using *HindIII/ClaI*. The DNA fragment was filled using the Klenow fragment of DNA polymerase. pAcUW51 was linearized with *BglII* and its ends blunted using the Klenow fragment. The DNA fragment was then inserted in the pAcUW51 expression construct of HuCC49HuK, downstream from the p10  
35 promoter.

**Example III. Generation of Baculovirus Recombinant CDR Substituted CC49 MAb**

5 Serum free adapted Sf9 insect cells (Gibco BRL, Gaithersburg, MD) were cultured at 28°C in Sf900-II medium (Gibco BRL) without supplements as described by Salgaller et al, (1993) Cancer Res., 53:2154-2161. To develop the recombinant baculovirus,  $1 \times 10^6$  Sf9 cells in a 35 mm dish were co-transfected with 0.5 ml pAcUW51 derived baculovirus expression construct of the CDR substituted  
10 light chain gene and the HuCC49 heavy chain gene along with linearized BACULOGOLD wild type baculovirus DNA (Pharmingen), using a cationic liposome mediated transfection system, DOTAP (Boehringer Mannheim) according to the suggested protocol. Similarly, variant antibodies containing CDR substituted heavy chain were produced by co-transfecting Sf9 cells with BACULOGOLD  
15 baculovirus DNA and baculovirus dual expression constructs carrying CDR substituted heavy chain and HuCC49 light chain genes. Baculovirus recombinant HuCC49 (hereafter referred to as HuCC49) was used as a control antibody. HuCC49 was produced by transfecting insect cells with pAcUW51 carrying HuCC49 light and heavy chains.

20 Five days after transfection, the infectious supernatants were harvested from the transfectants. 1 ml of this supernatant was serially diluted and used to infect a monolayer of  $5 \times 10^6$  Sf9 cells in a 100 mm dish. The cells were then overlaid with 0.5% Baculovirus Agarose (Invitrogen, Carlsbad, CA) as described by Bei et al., (1995) J. Immunol. Methods, 186:245-255. Viral plaques were expanded by three  
25 rounds of infection. For each round of expansion, a larger population of freshly seeded monolayers of Sf9 cells were infected, using the highest producing clone as a source of inoculum. The putative recombinant viral plaques were purified and isolated in 1 ml of Sf900 media. If necessary, viruses were further amplified by infecting cells at an Multiplicity of Infection (MOI) of 0.1. To produce the  
30 recombinant antibodies,  $6.0 \times 10^8$  Sf9 cells were infected with the infectious supernatant at an MOI of 5.

**Purification of CDR Substituted MAbs**

35 The culture supernatant was clarified by pelleting cell debris at 10,000xg, and was applied to an ion-exchange column (DE52; Whatman, Hillsboro, OR) at pH



7.2 to remove extraneous proteins. The unbound protein fraction was subjected to protein G (Gibco BRL) affinity chromatography. The material bound to protein G was eluted from the column using 0.1 M glycine hydrochloride buffer, pH 2.6 and the pH of the eluted material was immediately adjusted to 7.4 using 1.0 M Tris  
5 buffer, pH 8.0. The buffer was replaced by phosphate buffered saline and the eluted material was concentrated using a Centricon 30 micro concentrator (Amicon, Beverly, MA). Protein concentration was determined by the method of Lowry et al., (1951) J. Biol. Chem. 193:265–275. The purity of the antibody preparation was analyzed using a precast continuous 4–15% SDS–polyacrylamide Tris–glycine gel  
10 (Novex Systems, San Diego, CA) and visualized by Coomassie blue staining as described by Kashmiri et al., (1995) Hybridoma 14:461–473.

#### Radiolabeling of MABs

The murine MAb CC49 and HuCC49 were labeled with Na<sup>125</sup>I using the  
15 iodogen (Pierce, Rockford, IL) method as described by Fraker (1978) Biochem. Biophys. Res. Commun., 80:849–857 and Colcher (1988) Cancer Res., 48:4597–4603. The protocol routinely resulted in specific activities at 5–10 $\mu$ Ci/ $\mu$ g. The immunoreactivities of the radiolabeled MABs were assessed by the radioimmunoassay described by Schott et al., (1992) Cancer Res., 52:6413–6417  
20 using bovine submaxillary mucin (BSM) immobilized on a solid support (Reacti–gel HW 65F; Pierce)

#### Immunoglobulin Production

The titer of the transfectants and the putative viral plaques were assayed for  
25 immunoglobulin production by enzyme–linked immunosorbent assay (ELISA) based on reactivity of the test aliquot with goat anti–human Fc ( $\gamma$ 1) and goat anti–human kappa antibodies as described by Bei et al., (1995) J. Immunol. Methods, 186:245–255. Transfectants and viral plaques derived from each of the expression constructs were positive for immunoglobulin production.

30 However, when the transfectants and the viral plaques were assayed for immunoreactivity with TAG–72 positive bovine submaxillary mucin (BSM), the clones derived from the expression constructs carrying L–1, L–2 and L–1,2 were positive, while those generated by the H–2 expression construct were barely immunoreactive. Those derived from the constructs carrying either L–3, H–1 and  
35 H–3 demonstrated no immunoreactivity with BSM at all.

It was then assessed whether the poor or lack of BSM reactivity of the clones derived from L-3, H-1, H-2 and H-3 expression constructs was due to low levels of immunoglobulin secretion by these clones. To that end, Sf9 cells were infected with the infectious supernatants at an MOI of 5 and cultured under the conditions described above. The secreted antibody was purified from equal volumes of the culture supernatant from each of the infected cultures, and analyzed by SDS-PAGE. The gel profile under non-reducing conditions showed that the mobility of the variant antibodies was identical to that of the HuCC49, which has a molecular weight of approximately 160 kDa (data not shown). Under reducing conditions, the variant antibodies, like the HuCC49 MAb, yielded two protein bands of approximately 25-28 kDa and 50-55 kDa (Figure 6). These mobilities are in conformity with the molecular masses of the immunoglobulin heavy and light chains. More importantly, it is evident that regardless of their BSM reactivity, clones derived from each of the constructs encoding CDR-substituted heavy or light chain produce as much immunoglobulin as the clone derived from the constructs encoding the parental humanized heavy and light chains.

#### Example IV. Competition Radioimmunoassays for CDR Substituted Variants

##### 20 Binding Affinity of Variant Antibodies

The relative binding affinity of the HuCC49 and the CDR substituted variant antibodies to TAG-72 was determined using the competition radioimmunoassay (RIA) described by Milenic et al., (1991) Cancer Res., 51:6363-6371. Serial dilutions of the purified variant MAbs, as well as the parental HuCC49, were prepared in phosphate buffered saline (PBS) containing 1 % bovine serum albumin (BSA). 25  $\mu$ l was added to the wells of microtiter plates containing 10 ng BSM.  $^{125}$ I-labeled HuCC49 (50,000 cpm in 25  $\mu$ l) was then added to each well. The plates were incubated overnight at 4°C and then washed and counted in a  $\gamma$ -scintillation counter.

30 Unlabeled HuCC49 or its variants were used to compete for the binding of  $^{125}$ I-HuCC49 to TAG-72 positive BSM. The variants, L-1, L-2 and L-1,2, were found to completely inhibit the binding of the  $^{125}$ I-labeled HuCC49 to TAG-72, while L-3 did not compete at all (Figure 7).

The relative affinity constants were calculated by the modification of the Scatchard method described by Frankel et al., (1979) Mol. Immunol., 16:101-106.

An approximation of the specific activity of the  $^{125}\text{I}$ -HuCC49 was made and used to determine the final concentration for each of the dilutions of the variant MAb. The calculations were performed as described by Milenic et al., (1991) Cancer Res., 51:6363-6371.

5 The relative affinity constants ( $K_a$ ) of the variants were as follows:

- L-1 had a  $K_a$  of  $3.3 \times 10^{-8}$  M (only about 2-fold less than that of HuCC49).
  - L-2 had a  $K_a$  of  $6.81 \times 10^{-8}$  M (comparable to that of HuCC49).
  - L-1,2 had a  $K_a$  of  $2.9 \times 10^{-8}$  M (only about 2-fold less than that of HuCC49).
  - H-1 and H-3 displayed no competition
- 10 • H-2 competed only slightly with the HuCC49. The  $K_a$  of H-2 was  $0.018 \times 10^{-8}$  M (approximately 300-fold less than the  $K_a$  of HuCC49).

Reactivity of the CC49 anti-idiotypic antibodies to the variant antibodies

The variant MAbs were also characterized in the competition  
15 radioimmunoassay RIA described by Irvine et al., (1993) Cancer Immunol.  
Immunother., 36:281-292 using mouse anti-idiotypic MAb generated against MAb  
CC49. Three anti-idiotypic (AI49-8, AI49-3 and AI49-1) were selected,  
representing each of the anti-idiotypic subsets,  $\alpha$ ,  $\beta$ , and  $\gamma$ , respectively. In the same  
manner described above, 100 ng of MAb AI49-3 ( $\beta$ -subset), AI49-1 ( $\gamma$ -subset) or  
20 AI49-8 ( $\alpha$ -subset) were adsorbed to each well of a 96-well microtiter plate. 25  $\mu\text{l}$   
of the serially diluted variant MAbs or HuCC49 was added to each well along with  
25  $\mu\text{l}$  of  $^{125}\text{I}$ -murine CC49. The plates were washed and counted after an overnight  
incubation at 4°C.

The results for the light chain variants are shown in Figure 8. For the AI49-  
25 3 ( $\beta$ -subset): L-CDR1 appears to be only partially involved in the recognition of  
CC49 by AI49-3; L-CDR2 does not appear to be involved in the recognition of  
CC49 by AI49-3; and L-CDR3 appears to be important for recognition of CC49 by  
AI49-3. For the AI49-1 ( $\gamma$ -subset): L-CDR1 appears to be not required for  
recognition of CC49 by AI49-1; L-CDR2 appear to be only modestly involved in  
30 the recognition of CC49 by AI49-1; and L-CDR3 appears to be important for  
recognition of CC49 by AI49-1. For the AI49-8 ( $\alpha$ -subset): neither L-CDR1, L-  
CDR2, nor L-CDR3 appear to have any influence on the interaction of AI49-8 with  
CC49.

The results for the heavy chain variants are shown in Figure 9. For the  
35 AI49-3 ( $\beta$ -subset): H-CDR1 and H-CDR3 do not appear to be involved in binding

of HuCC49 to AI49-3, while H-CDR2 appears to be important for recognition of CC49 by AI49-3 (approximately 4-15 times more competitor is required for 50 % inhibition by H-2 as compared to HuCC49). For the AI49-1 ( $\gamma$ -subset): H-CDR1 and H-CDR3 do not appear to be involved in binding of HuCC49 to AI49-1, while  
5 H-CDR2 appears to be important for recognition of CC49 by AI49-1 (approximately 4-15 times more competitor is required for 50 % inhibition by H-2 as compared to HuCC49). For the AI49-8 ( $\alpha$ -subset): H-CDR1 and H-CDR3 do not appear to be involved in binding of HuCC49 to AI49-8, while H-CDR2 appears to be important for recognition of CC49 by AI49-8 (there is a complete loss of  
10 inhibition by the variant).

An analysis of patient reactivity to the variants of HuCC49 show that three of the 6 CDRs (L-CDR2, H-CDR1 and H-CDR3) do not seem to be recognized by the patient, while L-CDR1 and H-CDR2 appear to be involved in the patient's recognition of HuCC49 to some degree. L-CDR3 (which is important for antigen  
15 binding) is the immunodominant CDR recognized by the patient. L-CDR3 is immunodominant in mice as well (AI49-1 and AI49-3, the two anti-idiotypic antibodies that inhibit antigen binding of HuCC49, require L-CDR3 for recognition of HuCC49).

#### 20 Example V. High Performance Liquid Chromatography

The CDR variants were further characterized using the serum from a patient that had received  $^{177}\text{Lu}$ -CC49 in a phase 1 radioimmunotherapy clinical trial (Mulligan et al., (1995) Clin. Cancer Res., 1:1447-1454. Several of the patients in  
25 this study were found to have anti-idiotypic antibodies to MAAb CC49. One patient was selected to perform a preliminary study to identify whether any of the CC49 CDRs were immunodominant.

Using a modification of the method reported by Colcher et al., (1990) J. Nucl. Med., 31:1133-1142 and Mulligan et al., (1995) Clin. Cancer Res., 1: 1447-  
30 1454, serial dilutions of the purified CDR variants were incubated with the patient's sera along with  $^{125}\text{I}$ -labeled HuCC49. Specifically, the method of Colcher and Mulligan was modified as follows: prior to the study, HAMA and TAG-72 were removed from the sera by adsorption with CC92 conjugated solid support. The amount of sera required for half maximal complex formation with HuCC49 was then  
35 determined. Specifically, 8  $\mu\text{l}$  of patient sera was mixed with  $\sim 500,000$  cpm of  $^{125}\text{I}$ -

HuCC49 and serial dilutions of purified HuCC49 or its variants. The preparations were brought to a final volume of 50  $\mu$ l.

The ability of the variants to inhibit complex formation of the patient sera with  $^{125}$ I-labeled HuCC49 was monitored using HPLC analysis. 25  $\mu$ l of each solution was applied to a TSK3000 analytical column (7.8 mm x 30 cm; Tosohaas, Montgomeryville, PA) and eluted at 0.5 ml/min with 100 mM KCl in 67 mM sodium phosphate (pH 6.8). Radioactivity was monitored using a flow-through  $\gamma$ -scintillation detector (Model 170, Beckman).

If the variant contained the CDR recognized by the patient, then the variant would compete with the radiolabeled HuCC49 and complex formation would not occur and there would not be an alteration in the retention time of the  $^{125}$ I-HuCC49. If the variant no longer contained a CDR recognized by the patient, then complex formation would result. Thus, the ability of the CDR variants to inhibit complex formation of the patient sera with the radiolabeled HuCC49 was determined by the retention time of the  $^{125}$ I-HuCC49. The percent inhibition of complex formation was calculated and plotted versus concentration of each competitor to evaluate the degree of the patient's reactivity with the individual CDR variants. Figure 15 shows a comparison of patient reactivity with HuCC49 and CDR variants.

- L-1 (variant without CC49 L-CDR1) showed some inability to inhibit complex formation. Thus L-CDR1 appears to be somewhat involved in immunogenicity (0.7 $\mu$ g of competitor was required for 50% inhibition of complex formation).
- L-2 appeared to compete better than parental HuCC49 by 2 fold (an enhanced recognition by the patient)
- L-3 showed no inhibition of complex formation, thus L-CDR3 appears necessary for immunogenicity
- L-1,2 demonstrated some inability to inhibit complex formation, indicating that L-CDR1 and/or L-CDR2 are somewhat involved in immunogenicity.
- H-1 inhibits complex formation and therefore contributes to immunogenicity.
- H-2 showed little complex formation, thus H-CDR2 does not appear to be necessary for immunogenicity (10  $\mu$ g of competitor was unable to achieve 50% inhibition of complex formation).
- H-3 demonstrated some inability to inhibit complex formation, thus H-CDR3 appears to be somewhat involved in immunogenicity (0.4 $\mu$ g of competitor was required for 50% inhibition of complex formation).

Example VII. Preparation of SDR Substituted MAb CC49

5 Padlan et al., (1995) FASEB J., 9:133–139 disclose that the SDRs of light chain are bounded by positions 27d and 34; 50 and 55; and 89 and 96. The heavy chain SDRs are contained within positions 31 and 35b; 50 and 58; and 95 and 101.

Figure 2 shows the differences between the amino acid residues of the light chain CDRs of CC49 and LEN, and the heavy chain CDRs of CC49 and 21/28'CL.

10 In L-CDR1, CC49 and LEN differ in three residues; at positions 27b, 27f and 29. The residues at positions 27b (a buried residue) and 27f were found not to be directly involved in ligand contact, while the one at position 29 was found to interact with ligand in two complexes; in one only by main chain atoms. Residue 27b is located outside the suggested SDR boundaries. Residues 27f and 29 are well within the suggested SDR boundaries.

15 In L-CDR2, CC49 and LEN differ at position 53 only, and this position was found to be involved in ligand contact in only three of the 31 complexes of known structure. Residue 53 is well within the suggested SDR boundaries.

20 Since L-CDR1 and 2 of CC49 were replaced with their counterparts from LEN without any significant loss of antigen binding reactivity (above), it was concluded that residues 27b, 27f, 29 and 53 were not important for binding of CC49 to its antigen. L-CDR1 and L-CDR2 of CC49 were not considered for the mutation experiments because they were replaced with the corresponding CDRs of the human MAb LEN without significant loss of antigen binding reactivity.

25 The immunodominant L-CDR3 of CC49 differs from LEN at three positions, 94, 96 and 97. Each of the three residues of CC49 L-CDR3 was replaced with the residue present at the corresponding position in the LEN CDR to generate light chain variants <sup>94</sup>L, <sup>96</sup>L and <sup>97</sup>L, respectively. Another light chain variant, <sup>94,97</sup>L was generated carrying two substitutions, one at position 94 and the other at 97. Two additional variants were derived from the HuCC49 light chain variant L<sub>1,2</sub>, in  
30 which the L-CDR1 and L-CDR2 of CC49 were earlier replaced with their counterparts from the human MAb LEN. One variant, <sup>97</sup>L<sub>1,2</sub>, carried a single substitution at position 97. The other, <sup>94,97</sup>L<sub>1,2</sub>, had substitutions at two positions, 94 and 97.

35 Of the three residues that differ between L-CDR3 of CC49 and LEN, a partially buried residue at position 97 was not important for the antigen binding

activity of CC49. This residue is not located within the suggested boundary of SDRs of the L-CDR3. Thus, variant <sup>97</sup>L did not show any loss in antigen binding activity. Variant <sup>97</sup>L<sub>1,2</sub> showed only an insignificant loss of antigen binding activity.

5 Positions 94 and 96 of L-CDR3 are involved in ligand contact in 19 and 22 known antibody:antigen complexes, respectively. Thus it was consistent that variants <sup>96</sup>L and <sup>94</sup>L suffered total and near total loss of antigen binding reactivity. When the mutation at position 94 was imposed on the variants <sup>97</sup>L and <sup>97</sup>L<sub>1,2</sub>, it destroyed their antigen binding function.

10 H-CDR1 of CC49 and 21/28'CL differ at three positions, 31, 32 and 34. The residue at position 31 is directly involved in ligand binding in 12 of the 31 complexes; in five of those, only main chain atoms were involved. The residue at position 32 is ligand contacting in eight of the 31 complexes of known structure. The residue at position 34 is involved in ligand contact in none of the 31 complexes of known structure. Residues at positions 32 and 24 of the CC49 H-CDR1 were  
15 replaced with the corresponding residues of 21/28'CL MAb (<sup>32,34</sup>H) to test whether position 32 is important for ligand contact and in eliciting anti-idiotypic response.

H-CDR2 of CC49 differs from human MAb 21/28'CL at eleven positions. The residues at positions 60, 61, 62 and 64 were not ligand contacting in any of the complexes of known structure. Therefore, these residues of CC49 were prime  
20 candidates for replacement. Accordingly, a heavy chain variant of HuCC49, <sup>60-62,64</sup>H, was generated by replacing these residues of HuCC49 with their counterparts in human MAb 21/28'CL.

H-CDR3 was not considered for mutations, because it did not show any reactivity to patient's sera (above).

25 The following SDR variants were made:

- Variant <sup>94</sup>L: residue 94 of CC49 L-CDR3 was replaced with the residue present at the corresponding position in LEN.
- Variant <sup>96</sup>L: residue 96 of CC49 L-CDR3 was replaced with the residue present at the corresponding position in LEN.
- 30 • Variant <sup>97</sup>L: residue 97 of CC49 L-CDR3 was replaced with the residue present at the corresponding position in LEN.
- Variant <sup>94,97</sup>L: residue 94 and 97 of CC49 L-CDR3 was replaced with the residue present at the corresponding position in LEN.
- Variant <sup>97</sup>L<sub>1,2</sub>: derived from the HuCC49 light chain variant L<sub>1,2</sub>, in which the  
35 L-CDR1 and L-CDR2 of CC49 were replaced with their counterparts from the

human MAb LEN; residue 97 of CC49 L-CDR3 was replaced with the residue present at the corresponding position in LEN.

- Variant <sup>94,97</sup>L<sub>1,2</sub>: derived from the HuCC49 light chain variant L<sub>1,2</sub>, in which the L-CDR1 and L-CDR2 of CC49 were replaced with their counterparts from the human MAb LEN; residues 94 and 97 of CC49 L-CDR3 were replaced with the residue present at the corresponding position in LEN.
- Variant <sup>32,34</sup>H: residues at positions 32 and 24 of the CC49 H-CDR1 were replaced with the corresponding residues of 21/28'CL MAb.
- Variant <sup>60-62,64</sup>H: residues at positions 60, 61, 62 and 64 of the CC49 H-CDR1 were replaced with the corresponding residues of 21/28'CL MAb.

#### Production of Oligomers

The oligomers were produced essentially as described in Example 1.

pLgpCXHuCC49Huy1, the expression construct for parental HuCC49 heavy chain genes was used as the template for heavy (<sup>32,34</sup>H and <sup>60-62,64</sup>H) chain variant gene synthesis. pLNCXHuCC49HuK, the expression construct of the parental HuCC49 light chain gene was used as a template for the light (<sup>94</sup>L, <sup>96</sup>L, <sup>97</sup>L and <sup>94,97</sup>L) chain variant gene synthesis. Variants L<sub>1</sub> and L<sub>1,2</sub> were developed by replacing only the L-CDR1 or both L-CDR1 and L-CDR2 of CC49, respectively, with their LEN counterparts. For the synthesis of <sup>94</sup>L<sub>1,2</sub> and <sup>94,97</sup>L<sub>1,2</sub> genes, an expression construct of the L<sub>1,2</sub> variant in a baculoviral expression construct was used as a template.

Mutagenic oligonucleotide primers, ranging in size from 37 to 56 nucleotides, were synthesized using a Model 8700 DNA synthesizer (Milligen/Bioresearch, Burlington, VT). They were purified on oligo-Pak columns (Milligen/Bioresearch) according to the supplier's recommendation. The sequences of the mutagenic primers were as follows, where the mutagenic changes are underlined:



V<sub>L</sub> CDR3:

5'-GCC AGC GCC GAA GCT GAG GGG ATA GCT ATA ATA CTG CTG ACA-  
3'

5'-GGT GCC AGC GCC GAA GCT GAG GGG GGT GCT ATA ATA CTG CTG  
5 ACA-3'

5'-GCC ACG GCC GAA TGT GTA GGG ATA GCT ATA ATA CTG CTG ACA  
-3'

5'-GCC GAA TGT GAG GGG GGT GCT ATA ATA CTG CTG ACA ATA-3'

10 V<sub>H</sub> CDR1:

5'-GTT TCA CCC AGT GCA TTG CAT AAT CAG TGA AGG TGT A-3'

V<sub>H</sub> CDR2:

5'-GTG GCC TTG CCC TGG AAC TTC TGT GAG TAC TTA AAA TCA TCG

15 TTT CCG GGA GAG AA-3'

#### Example VIII. Assembly of PCR Products

The PCR products were assembled and sequenced as described in Example  
20 II. The 425 base pair (bp) PCR product obtained using the HuCC49 light chain  
construct as a template carried sequences encoding the leader peptide, the CC49 V<sub>L</sub>  
domain and the amino terminus of the kappa (k) constant region, terminating in a  
SacII site located 10 bp downstream of the V<sub>L</sub>. Similarly, the 432 base pair (bp)  
PCR product from the heavy chain template encompassed sequences encoding the  
25 leader, the V<sub>H</sub> and the amino terminus of the C<sub>H1</sub> domain, extending to the *Apa*I site,  
which is located 17 bp downstream from the start of the C<sub>H1</sub> domain.

#### Generation of Recombinant SDR Substituted CC49 MAb

SDR substituted variants were generated essentially as described Example  
30 III, except for the following. The Sf900-II medium included 50 µg/ml of antibiotic,  
gentamicin and the infectious supernatants were harvested six days after  
transfection.

Purification of SDR Substituted CC49 MAb

Three days after infection, the tissue culture supernatant was harvested and clarified by centrifugation at 2000xg for 10 minutes. Tris buffer was added to the supernatant to a final concentration of 20 mM. Following incubation at 4°C for 2–3  
5 hours, any contaminating proteins were pelleted by centrifugation at 10,000xg for 15 minutes. The supernatant was applied to a protein G agarose column (Gibco BRL) and the bound protein was eluted from the column, using 0.1 M glycine hydrochloride, pH 2.5. The pH of the eluted material was immediately adjusted to 7.0 with 1.0 M Tris buffer, pH 8.0. The protein was concentrated using a Centriplus  
10 30 microconcentrator (Amicon, Beverly, MA), centrifuged at 3000xg for 80 minutes. The concentrated protein was recovered in phosphate-buffered saline (PBS). The protein concentration was determined by the as described in Example III. The purity of the antibody preparation was evaluated by electrophoresis on 4–12% SDS–PAGE, under reducing and non-reducing conditions. The proteins were visualized  
15 by staining with Coomassie blue, as described in Example III.

Example IX. Competition Radioimmunoassays for SDR Substituted Variants

ELISA

20 The ability of the variants to express immunoglobulin molecules and their antigen reactivity of the heavy (<sup>32,34</sup>H and <sup>60–62,64</sup>H) or variant light (<sup>94</sup>L, <sup>96</sup>L, <sup>97</sup>L, <sup>94,97</sup>L, <sup>97</sup>L<sub>1,2</sub> and <sup>94,97</sup>L<sub>1,2</sub>) chain variants was evaluated using ELISA assays.

ELISA assays were carried out by coating individual wells of a 96-well polyvinyl microtiter plates with 1 µg/well of TAG-72 positive bovine submaxillary  
25 mucin (BSM) (Sigma Chem. Co., St. Louis, MO), and following the procedure described by Bei et al., (1995) *J. Immunol. Methods*, 186:245–255.

Not all variant antibodies were positive for antigen binding activity. Results of the ELISA assay for the binding activity to the TAG-72 positive BSM showed that the variant antibodies specified by expression constructs carrying the variant  
30 genes <sup>32,34</sup>H and <sup>96</sup>L were not reactive with BSM. In contrast, variant antibodies expressed by <sup>97</sup>L and <sup>60–62,64</sup>H constructs showed strong BSM binding activity. While immunoglobulin molecules expressed by <sup>94</sup>L and <sup>94</sup>L<sub>1,2</sub> constructs showed moderate positive antigen binding reactivity, those expressed by <sup>94,97</sup>L<sub>1,2</sub> were only weakly positive. (Figure 13)

A partial or complete loss of antigen binding activity of the variant immunoglobulins might be attributed to the detrimental effect of the SDR substitutions on the combining site of HuCC49. Alternatively, the plaques may show lower or no antigen binding reactivity because some of the expression constructs failed to express, were expressing at significantly lower level, or producing antibodies that were not physically normal. To examine these possibilities, variant antibodies were produced and purified from a larger batch of cells that were freshly infected with inoculum derived from the highest producing clone for each of the constructs. The concentration of the secreted variant antibodies in culture supernatants ranged between 2–3 µg/ml. Purified immunoglobulin molecules were characterized by SDS–PAGE. Under reducing conditions, immunoglobulin molecules expressed by each of the constructs yielded two bands that co–migrated with the heavy and light chains of HuCC49 MAb (data not shown). Antibodies produced by the insect cells harboring expression constructs <sup>97</sup>L<sub>1,2</sub> and <sup>94,97</sup>L<sub>1,2</sub> genes paired with the HuCC49 heavy chain gene showed similar results (data not shown). These results make it evident that all constructs expressed and produced comparable levels of immunoglobulin molecules of appropriate size. Therefore, it can safely be concluded that the variant HuCC49 MAbs carrying <sup>96</sup>L and <sup>32,34</sup>H substitutions suffered a total loss of antigen binding activity.

#### Competition Radioimmunoassay

Competition radioimmunoassays (RIAs) were performed to determine relative binding of the variant MAbs and the parental HuCC49 to BSM. Details of the procedure are described by Kashmiri et al., (1995) *Hybridoma*, 14:461–473. Serial dilutions of the purified unlabeled variant antibodies or the parental HuCC49 MAb were used to compete with radiolabeled HuCC49 for binding to the TAG–72 positive BSM. Briefly, 25 µl of serial dilutions of the purified SDR substituted variants or the parental HuCC49 in PBS containing 1% BSA were added to wells of 96–well microtiter plates containing 10 ng of BSM. 25 µl of <sup>125</sup>I–labeled HuCC49 (50,000 cpm) was added to each well to compete with the unlabeled parental or variant HuCC49 for binding to the BSM coated on the plates. The plates were incubated overnight at 4°C and then washed and counted in a γ–scintillation counter.

Competition profiles of the light chain variants presented in panel A show that the variant <sup>96</sup>L failed to compete, while all other variants antibodies competed with the parental HuCC49 completely and with similar slopes. (Figure 13)

However, the competition curves of all variants with the exception of <sup>97</sup>L were shifted significantly to the right, indicating a loss of reactivity with antigen (BSM). This shift was notably less pronounced for <sup>97</sup>L<sub>1,2</sub>. Similarly, it is evident from the competition profiles of the heavy chain variants (panel B) that the variant MAb <sup>32,34</sup>H, with substitutions in H-CDR1, did not inhibit binding of HuCC49 MAb to BSM, whereas <sup>60-62,64</sup>H, the variant with substitutions in the H-CDR2, competed completely with a profile that was almost identical to that of the parental HuCC49.

The relative affinity constants were calculated as described in Example IV. The relative affinity constants (K<sub>a</sub>) of the variants were calculated from the linear parts of the competition curves. The K<sub>a</sub> of <sup>97</sup>L and <sup>60-62,64</sup>H MAbs were 3.6x10<sup>8</sup> M<sup>-1</sup> and 2.2x10<sup>8</sup> M<sup>-1</sup>, respectively. These values are comparable to 3.2x10<sup>8</sup> M<sup>-1</sup>, the K<sub>a</sub> of the parental HuCC49. The variant <sup>97</sup>L<sub>1,2</sub> was found to have a K<sub>a</sub> of 1.4x10<sup>8</sup> M<sup>-1</sup>, which is approximately 2- to 3-fold less than the K<sub>a</sub> of HuCC49 MAb.

Two new expression constructs were then generated and expressed in Sf9 cells; in one of them, the gene encoding the variant heavy chain <sup>60-62,64</sup>H was paired with the gene encoding the light chain variant <sup>97</sup>L. Gene <sup>60-62,64</sup>H was paired with the <sup>97</sup>L<sub>1,2</sub> light chain gene in the other construct. Competition profiles of the purified antibodies show that these variant MAbs competed completely with HuCC49 MAb for antigen binding, yielding competition curves of the same slope as HuCC49.

(Figure 13) The relative affinity constant of the Variant MAb <sup>97</sup>L/<sup>60-62,64</sup>H was 5.48x10<sup>8</sup> M<sup>-1</sup>, a figure favorably comparable to that of HuCC49, while the K<sub>a</sub> of the variant MAb <sup>97</sup>L<sub>1,2</sub>/<sup>60-62,64</sup>H was 1.15x10<sup>8</sup> M<sup>-1</sup>, which is about 3-fold less than that of the parental HuCC49 MAb.

#### 25 Example X. High Performance Liquid Chromatography

In a reported Phase I clinical trial, in which <sup>177</sup>Lu-labeled MAb CC49 was administered to adenocarcinoma patients, several patients were found to have anti-idiotypic antibodies to MAb CC49. Sera collected from the study was used to examine the potential immunogenicity of the variants. The sera was obtained by separating the blood by centrifugation. High Performance Liquid Chromatography (HPLC) was used to determine antigen reactivity of the variants by monitoring complex formation between antibodies in the patient sera and the variant MAbs.

Prior to HPLC analysis, any free TAG-72 and human anti-murine antibodies other than anti-idiotypic antibodies to CC49 present in the sera were absorbed out

using MAb CC92 conjugated to a solid support. MAb CC92 is a murine anti-TAG-72 antibody which has the same isotype as CC49 and recognizes an epitope of TAG-72 other than that recognized by CC49. Patient sera was then incubated with  $^{125}\text{I}$ -labeled HuCC49 (approximately 500,000 cpm) and 5  $\mu\text{g}$  of the cold competitor; either HuCC49 or one of the variant MAbs.

The competition assay is described in Example V. Briefly, patient sera was mixed with  $\sim 0.3 \mu\text{Ci}$  of  $^{125}\text{I}$ -HuCC49 and serial dilutions of purified HuCC49 or its variants. Prior to the assay, the amount of sera required in half-maximal immune complex formation was determined. The mixture was brought to a final volume of 50  $\mu\text{l}$ . 25  $\mu\text{l}$  of the final solution was applied to a 7.8 mm x 30 cm TSK3000 analytical column (Tosohaas, Montgomeryville, PA) and eluted at 0.5 ml/min with elution buffer (100 mM KCl in 67 mM sodium phosphate, pH 6.8). Radioactivity was monitored using a flow-through Model 170  $\gamma$ -scintillation detector (Beckman).

Complex formation of the radiolabeled HuCC49 with the anti-idiotypic antibodies in patient sera reduced the retention time of the radiolabel on the column. The ability of the variant to inhibit complex formation with  $^{125}\text{I}$ -labeled HuCC49 was determined by the differential in the retention time of the radiolabel on HPLC column, when a mixture of sera and  $^{125}\text{I}$ -labeled HuCC49 was loaded on the column with or without incubation with the cold competitor. Inhibition of complex formation by a competitor indicates that the competitor shares the immunogenic epitope with HuCC49. (Figure 14)

From an analysis of the percent of input counts recovered as a complex, when a mixture of  $^{125}\text{I}$ -labeled HuCC49 and sera from each of the four patients was incubated with 5  $\mu\text{g}$  of cold competitor and subjected to HPLC analysis, it is evident that the variant antibodies  $^{97}\text{L}$  and  $^{32,34}\text{H}$ , like HuCC49, inhibited complex formation. In contrast, the variant MAbs  $^{96}\text{L}$  and  $^{94,97}\text{L}_{1,2}$ , like the nonspecific Human immunoglobulin did not inhibit complex formation of HuCC49 with sera from any patient except EA. Complex formation with EA sera was partially inhibited by the two variants. The variant MAbs  $^{94}\text{L}$ ,  $^{94,97}\text{L}$ ,  $^{97}\text{L}_{1,2}$  and  $^{60-62,64}\text{H}$  inhibited complex formation only partially with sera from all patients. The variant  $^{97}\text{L}/^{60-62,64}\text{H}$ , whose antigen binding activity was comparable to that of parental HuCC49, inhibited sera of three patients (DG, CP and DS) only partially, but completely inhibited the sera from EA patient to form complexes with HuCC49. More importantly, the variant  $^{97}\text{L}_{1,2}/^{60-62,64}\text{H}$  did not compete with HuCC49 to form complex with anti-idiotypic antibodies present in sera from two patients (CP and

DS) while showing only partial competition with sera from two other patients (DG and DS).

Using serial dilutions of the competitors, competition profiles were developed to determine the relative amounts of unlabeled competitor antibodies required to achieve 50% competition of the binding of  $^{125}\text{I}$ -labeled HuCC49 to the anti-idiotypic antibodies present in sera from one of the patients (CP). The percent inhibition of complex formation was calculated and plotted versus the concentration of competitor.

The competition profiles show that the cold HuCC49 competed completely and it required approximately 250 ng of the parental HuCC49 antibody to achieve 50% competition. In contrast, variant  $^{97}\text{L}_{1,2}/^{60-62,64}\text{H}$  inhibited binding of the radiolabeled HuCC49 to the sera anti-idiotypic antibodies only minimally; even 1  $\mu\text{g}$  of the variant failed to achieve more than 25% competition, that was achieved by 60 ng of HuCC49. This variant, which retains moderate antigen binding activity and reacts with patient's sera only minimally, might be most advantageous for clinical applications. This variant was further studied for plasma clearance and biodistribution in an animal model.

Figure 16 is a graph showing the immunoreactivity of variant  $^{97}\text{L}_{1,2}/^{60-62,64}\text{H}$  to human sera containing anti-murine CC49 variable region antibodies as assessed by HPLC analysis. The percent inhibition of the complex formation was calculated and plotted versus ng of the competitors. The competitors were HuCC49 (■) and variant (□).

#### Example XI. Biodistribution and Pharmacokinetic Studies

##### Pharmacokinetics

Since the rate of plasma clearance has a bearing on *in vivo* tumor targeting, a comparison of the pharmacokinetics of the variant to the parental HuCC49 was assessed using the procedures described by Kashmiri et al., (1995) Hybridoma, 14:461-473.

To study pharmacokinetics, athymic mice bearing TAG-72 positive LS-174T tumors (Colcher et al., (1983) Cancer Res., 43:736-742) were injected intravenously in the tail vein with a mixture containing 1.4  $\mu\text{Ci}$   $^{131}\text{I}$ -labeled HuCC49 and 4.4  $\mu\text{Ci}$   $^{125}\text{I}$ -labeled variant MAAb  $^{97}\text{L}_{1,2}/^{60-62,64}\text{H}$ . Blood samples were collected at various time points via the tail vein into 10  $\mu\text{l}$  heparinized capillary tubes

(Drummond, Broomall, PA). The amounts of  $^{131}\text{I}$  and  $^{125}\text{I}$  in the plasma were determined and corrected for the respective rates of the decay of the two radionuclides. The percentage of the injected dose of each radionuclide remaining in the plasma was then calculated for each time point. The results suggest that the blood clearance patterns of the two antibodies are not significantly different. (Figure 17). For 50% of the injected dose of the HuCC49 or variant to clear the blood compartment, required 1 and 2 hours, respectively. At 24 hours, 85% and 80% of the radiolabeled HuCC49 and the variant, respectively, was cleared from the blood. At 48 hours, the percentage of HuCC49 and the variant cleared from the blood was 92% and 88%, respectively.

### Biodistribution

Biodistribution assays were performed as described by Kashmiri et al., (1995) Hybridoma, 14:461–473. To investigate the ability of the variant HuCC49 MAb to localize to human tumor xenograft and determine radiolocalization index (RI), athymic mice bearing TAG–72 positive LS–174T tumors (Colcher et al., (1983) Cancer Res., 43:736–742) were injected intravenously in the tail vein with a mixture containing 1.4  $\mu\text{Ci}$   $^{131}\text{I}$ –labeled HuCC49 and 4.4  $\mu\text{Ci}$   $^{125}\text{I}$ –labeled variant MAb  $^{97}\text{L}_{1,2}/^{60-62,64}\text{H}$ . The amount of  $^{131}\text{I}$  and  $^{125}\text{I}$  were determined in blood samples collected via tail vein at specified times. For each time point, 5 mice were sacrificed to collect and weigh tumor, blood and all other major organs. Radioactivity was measured in a  $\gamma$ –scintillation counter and it was corrected for the decay. The percentage of the injected dose per gram (%ID/gm) for each organ was determined.

The % injected dose of the two antibodies per gram of either tumor or different normal tissues that were collected at different time points shows that the biodistribution patterns of the two antibodies are essentially the same. Both showed significant tumor localization by 24 hours. (Figure 18) By 48 hours, when only 8% and 12% of the injected dose was present in the blood, 17.6% and 23.8% ID/b of HuCC49 and the variant were, respectively, present in the tumor.

### Example XII. Characterization of Humoral Immune Response against CC49

In this Example, the humoral immune response against HuCC49 CDR–replacement variants is examined.

Generation of Humanized CC49 (HuCC49) and Humanized CC49 CDR-  
Replacement Variants (CDR variants)

5 A clone producing humanized CC49 (HuCC49) was grown in protein free  
hybridoma medium PFHM-II (GIBCO-BRL, Gaithersburg, MD) as described by  
Kashmiri (1995), Hybridoma, 14:461-473. The humanized CC49 monoclonal  
antibody (MAb) was purified from the tissue culture supernatant by Protein G  
affinity chromatography as described by Kashmiri (1995), Hybridoma, 14:461-473.

10 Seven HuCC49 CDR-variants were produced as described in Examples I-  
III.

Radiolabeling

MAb HuCC49, BL-3 and the CDR-replacement variants of HuCC49 were  
labeled with Na<sup>125</sup>I using the iodogen method (Pierce, Rockford, IL) as described by  
15 Fraker et al. (1978), Biochem. Biophys. Res. Commun. 80:849-857; and Colcher et  
al. (1988), Cancer Res., 48:4597-4603. BL-3 is an isotype-matched control for  
CC49 (described by Colcher et al. (1987), Cancer Res., 47:4218-4224). The  
labeling procedure typically resulted in specific activities of 5-10  $\mu\text{Ci}/\mu\text{g}$ .

20 Patients and Sample Collection

Patients with recurrent metastatic adenocarcinoma were enrolled in a Phase I  
Study to assess the maximum tolerated dose of intravenously administered  
<sup>177</sup>Lutetium radiolabeled MAb CC49 (Mulligan, (1995) Clin. Cancer Res. 1:1447-  
1454).

25 In the Phase I Study, adenocarcinoma patients were given a test dose of 0.1  
mg (i.v. bolus) of MAb CC49 and observed for 30 minutes prior to administration of  
the <sup>177</sup>Lu-labeled MAb CC49. The radiolabeled MAb was given as a 1 hour i.v.  
infusion. Blood samples were collected prior to and at the end of the infusion, and  
0.5, 1 and 2 hours after the infusion, and afterward, daily for 7 days. Patients  
30 returned for a follow-up examination at 3, 6 or 8 weeks, at which time blood  
samples were collected. Sera was separated and stored at -20°C until analyzed.  
Sera from these patients provided a resource for assessing the humoral response of  
patients to the murine MAb CC49. The patient characteristics are presented in Table  
1, below.

35



**Table 1: Patient Characteristics**

Dose Level	Patient	Age	Sex	Tumor	Dose <sup>a</sup>	
					mCi	mg MAb
10 mCi/m <sup>2</sup>	DS	52	F	Breast	16.0	20
	LW	45	F	Breast	19.0	20
	JJ	61	F	Breast	17.2	20
25 mCi/m <sup>2</sup>	DG	45	F	Breast	41.0	20
	LJ	45	F	Breast	40.3	20
	JM	42	F	Breast	45.4	20
15 mCi/m <sup>2</sup>	JG	61	M	Colon	29.8	44
	RW	46	F	Lung	24.2	20
	TD	50	M	Colon	31.5	47
	EA <sup>b</sup>	53	F	Colon	24.2	20
	CP <sup>b</sup>	53	F	Colon	26.0	20
	LQ <sup>b</sup>	45	F	Colon	29.7	20

<sup>a</sup> Patients were administered <sup>177</sup>Lu-PA-DOTA-CC49 by intravenous injection.

<sup>b</sup> Patient received new formulation of <sup>177</sup>Lu-PA-DOTA-CC49 that was labeled using a modification of the method described by Mulligan et al. (1995), Clin. Cancer Res. 1:1447-1454.

5

PA-DOTA was conjugated to human serum albumin (HSA), radiolabeled with Na<sup>125</sup>I, incubated with the patient sera and analyzed for immune complex formation by size-exclusion HPLC. None of the sera showed detectable reactivity with the PA-DOTA-HSA conjugate (Data not shown).

10

#### Determination of Patient Humoral Response

The sera from the twelve patients was evaluated for the presence of human anti-murine antibodies (HAMA) in response to MAb CC49 using high performance liquid chromatograph (HPLC) as described by Mulligan et al. (1996) Clin. Cancer Res. 1:1447-1454. The analysis was performed by adding about 500,000 cpm (0.4μCi) of <sup>125</sup>I-BL-3 to 50 μl of patient sera. Following a 60 minute incubation at 37°C, 25 μl of the mixture was applied to a size-exclusion column (TSK 3000SW; TosoHaas, Montgomeryville, PA) equilibrated in 67 mM sodium phosphate (pH 6.8) containing 100 mM KCl. The sera samples were eluted at a flow rate of 0.5 ml/min. The protein was detected by absorbance at 280 nm and the radioactivity was measured using a flow-through γ-scintillation counter (Model 170, Beckman Instruments, Inc., Berkeley, CA). The presence of HAMA was indicated by a shift in the elution profile of the <sup>125</sup>I-BL-3 because the formation of immune complexes with the radiolabeled BL-3 results in a shorter retention time. The patients' pre-study sera, normal human sera and phosphate buffered saline with <sup>125</sup>I-BL-3 were used as controls. A patient with a known HAMA response from a previous study

15

20

25

(Colcher et al. (1990), *J. Nucl. Med.*, 31:1133-1142) served as a positive control. The patients' sera were demonstrated to have antibodies against the variable region of the murine CC49.

Figure 19 shows an HPLC analysis of patient HAMA following intravenous injection of  $^{177}\text{Lu}$ -CC49. Serum samples from LQ were analyzed for the presence of HAMA at various timepoints before and after injection with 20 mg of  $^{177}\text{Lu}$ -labeled CC49. Pre-study sera (A), sera collected at 7 days (B), 3 weeks (C), and 6 weeks (D) were mixed with  $^{125}\text{I}$ -BL-3 and applied to a size exclusion column. Reduction in retention time of the radiolabeled BL-3 as compared to migration of the  $^{125}\text{I}$ -BL-3 in buffer (E) were indicative of immune complex formation and therefore the presence of HAMA.

Lack of complex formation is evident (FIG. 19A) when the pre-study sera of Patient LQ is incubated with the  $^{125}\text{I}$ -BL-3. All of the radioactivity is associated with the peak at about 18.5 minutes, the same retention time for  $^{125}\text{I}$ -BL-3 in buffer (FIG. 19E). Complex formation is also absent when the sera collected at seven days is incubated with  $^{125}\text{I}$ -BL-3 (FIG. 19B). With sera collected at 3 weeks (FIG. 19C), however, there is an indication of complex formation (46%) with the appearance of two peaks with a shorter retention time (i.e., 14 and 16 minutes). The peaks at a shorter retention time indicate the development of a higher molecular weight species in the sera. At 6 weeks (FIG. 19D), the HAMA response has increased, the amount of radioactivity bound in complexes is now 66%.

Figure 20 shows an HPLC analysis of patients' humoral response to the variable region of MAb CC49. The percent complex formation has been plotted versus time for (solid lines) patients DS (O), LW (□), JJ (Δ), DG (●), LJ (■), TD (▲); (dotted lines) JG (O), RW (□), JM (Δ), EA (●), CP (■), LQ (▲);

At one week, none of the patients showed a detectable response against the HuCC49 (FIG. 20). At 3 weeks, sera from nine of the twelve patients (75%) appears to contain antibody against the variable region of CC49 with one patient having a notably higher response than the others. For the eleven patients evaluated at six weeks, only two patients did not elicit a human antiviral region antibody response (HAVRA) against CC49, i.e., 9 of 11 evaluable patients (82%) had antibody against the variable region of the murine MAb CC49.

Three patterns of HAMA-HAVRA response are evident. The patterns of the HAMA and HAVRA responses elicited in each of the patients were very similar, differing only in the apparent level of antibody. Patients DG, LW, LQ and CP

developed HAVRA simultaneously with HAMA. Patients DS and JM appear to have a strong HAVRA, while HAMA response is modest. While in patients TD, JG, and EA, the HAVRA level is lower than HAMA at 3 weeks, followed by HAMA and HAVRA attaining high levels at later timepoints. In no patient was there a  
 5 HAVRA response without the development of HAMA..

The HAMA results for the twelve patients are summarized below in Table 2.

**Table 2: HPLC Analysis of Patients' Anti-mouse immunoglobulin response after i.v. injection of  $^{177}\text{Lu-CC49}$**

Patient	Days Post-Injection of $^{177}\text{Lu-CC49}$			
	7	21	42	56
DS	0 <sup>a</sup>	1	16	27
LW	3	6	81	NA
JJ	0	12	3	4
DG	0	24	84	NA
LJ	0	42	NA	NA
JM	0	8	47	NA
JG	4	83	83	NA
RW	0	1	2	NA
TD	0	95	100	NA
EA	0	27	100	100
CP3	0	33	27	NA
LQ	0	46	66	100

<sup>a</sup> The values are the percent of  $^{125}\text{I-BL-3}$  detected in complexes after a brief incubation with the patient sera and resolved by size-exclusion chromatography. The timepoints of each patient are background corrected using the patients' pre-study sera.

The patterns of the HAMA responses are varied and are consistent with previous findings by Colcher et al. (1990), *J. Nucl. Med.* 31:1133–1142. Ten out of the twelve patients (83%) demonstrate a HAMA response at 3 weeks following a single intravenous injection of 20 mg  $^{177}\text{Lu}$ -labeled CC49, two patients (LW and JG) have minimal responses evident at 7 days with complexes of 3% and 4%, respectively. One patient (RW) may be considered a nonresponder. Some of the patients show an escalating HAMA response, while others plateau. Yet another (JJ) peaks at 3 weeks, followed by an apparent decrease in the HAMA level. Overall, at 3 weeks, 8 of 12 patients (57%) at and 6 weeks, 9 of 11 (82%) were HAMA positive.

#### Specificity of Patient Response

The specificity of the patients' antibody response to CC49 was assessed using  $^{125}\text{I}$ -labeled HuCC49 and HuCC49 CDR-replacement variants to determine whether or not any of the responses were directed against the variable region of CC49. To accomplish this, the HPLC methodology was employed using  $^{125}\text{I}$ -HuCC49 as the probe (See, Kashmiri et al. (1995), *Hybridoma*, 14:461–473).

To eliminate the artifactual influence of TAG-72 in the HPLC analysis for anti-CC49 antibody responses found in the patient's serum, immunoadsorbents were prepared as reported by Ferroni et al. (1992) *J. Clin. Lab. Analysis*, 4:465–473. For the purpose of these studies, purified MAb CC92 was coupled to Reacti-gel (HW65F, Pierce) according to the method of Heam et al. (1979), *J. Chromatog.*, 185:463–470. MAb CC92 is a second-generation monoclonal antibody that reacts with TAG-72, but with an epitope distinct from the one recognized by CC49.

Before probing the patients' sera with the  $^{125}\text{I}$ -HuCC49, removal of HAMA and circulating TAG-72 were confirmed using  $^{125}\text{I}$ -BL-3 and  $^{125}\text{I}$ -B72.3, respectively (data not shown). MAb B72.3 is an anti-TAG-72 MAb that has been shown to form complexes with TAG-72 in patient sera (Colcher et al. (1990), *J. Nucl. Med.*, 31:1133–1142).

In the competition assay, 5  $\mu\text{g}$  of the cold competitor (either purified HuCC49 or one of its variants) was added to a mixture of patient sera (collected 8 weeks post-i.v. injection with  $^{177}\text{Lu}$ -CC49) and  $^{125}\text{I}$ -HuCC49 and then analyzed by size-exclusion chromatography for the absence or presence of complexes. The percent inhibition of complex formation was calculated. If the variant competed with the  $^{125}\text{I}$ -labeled MAb, and complex formation was inhibited, then the variant

still contained the immunodominant CDR. If the variant failed to inhibit complex formation, then the CDR that is no longer present in the variant is recognized by the patient and hence it is an immunogenic CDR. An example of this assay (using serum from patient LQ) is shown in FIG. 21. Panel A is the profile of the <sup>125</sup>I-HuCC49 in buffer only. Panel B, is the profile showing complex formation (42.9%) resulting from patient sera (LQ) incubated with <sup>125</sup>I-HuCC49. When HuCC49 is added as a competitor, there is competition for the <sup>125</sup>I-HuCC49 and a loss or absence of complexes is observed (Panel C). The same is true of a variant which still contains an immunogenic CDR (e.g., light chain CDR2 as the competitor) (Panel D). In contrast, there is either a partial (Panel F) or total retention of the complexes (Panel E), when light chain CDR1 or CDR3 variants, respectively, are the competitors.

The results are very striking, see Table 3.

**Table 3: HPLC Analysis of Patient Reactivity to CDR-Replacement variants of HuCC49<sup>a</sup>**

Competitor	CDR <sup>b</sup>	Patient					
		DS	DG	JG	EA	CP	LQ
None	—	33.5 <sup>c</sup>	46.2	24.5	56.8	32.2	42.9
HuCC49	—	0	0	2.6	0.5	1.5	3.0
Hu IgG	—	46.4	59.0	25.1	63.6	ND	54.1
Light Chain	1	16.0	12.2	9.8	10.1	16.9	14.3
	2	2.7	3.4	2.7	4.4	3.0	2.4
	3	34.8	48.2	22.4	37.6	33.5	46.7
	1,2	24.6	24.5	12.6	19.4	15.7	20.2
Heavy Chain	1	10.2	3.9	3.3	7.0	5.8	3.5
	2	32.7	32.5	12.7	24.7	29.7	36.6
	3	7.3	5.1	3.7	8.2	6.7	4.6

<sup>a</sup> The sera from patients injected with <sup>111</sup>Lu-CC49 were tested for reactivity with variants of HuCC49 in which individual CDRs had been substituted with human sequences in both the heavy and light chains of HuCC49. Five µg of the purified CDR-replacement variants were added to a mixture of <sup>125</sup>I-HuCC49 and the patient sera and then analyzed for the presence or absence of immune complex formation.

<sup>b</sup> The number indicates which CDR in the HuCC49 has been replaced with a human CDR sequence.

<sup>c</sup> The values are the percent of complexes, the higher molecular weight species, resolved by size-exclusion chromatography.

Of the six patients analyzed, all six demonstrated reactivity with CDR3 light chain indicating that light chain CDR3 may be immunodominant in murine CC49 MAb. In the heavy chain, CDR2 appears to be dominant but not with the same level of consensus (four of the six patients show the same level of reactivity, the other two

demonstrated partial reactivity). Concordance was obtained among the six patients in regard to CDR2 of the light chain and CDR1 and CDR3 of the heavy chain, which do not appear to contribute to the immunogenicity of the MAb. This is also the case with the light chain CDR1 and, it follows, the variant with the dual substitution of CDR1 and 2 in the light chain, in which all six patients displayed a partial recognition of the variants. Partial recognition with the heavy chain CDR2 variant with two patients may be due to a loss of part but not all of the cognizant epitope, a change in the conformation or conformational epitope, or loss of amino acid residues that might stabilize the antibody:antibody interaction.

10

Quantitation of Patient Antibody Response

Quantitation of the HAMA or anti-variable region antibody levels in four patients was performed using HPLC analysis. The quantitation study was performed by adding either 500 ng of unlabeled BL-3 or 250 ng of HuCC49, respectively, to the mixture of patient serum and <sup>125</sup>I-HuCC49 and calculating the amount of BL-3 or HuCC49 bound in complexes.

15

As shown in Table 4, below, at 6 weeks, the amount of HAMA varies from patient to patient by 43-fold, while the variability of HAVRA is within 4-fold. Furthermore, the HAMA versus HAVRA levels may vary from 10 to 145-fold. Clearly, HAVRA can be detected at 3 weeks, and, not surprisingly, it does not appear to attain the same levels as HAMA. In patient EA, there is a dramatic 10-fold increase in the level of HAVRA from 6 to 8 weeks that is noteworthy.

20

**Table 4: Quantitation of anti-CC49 variable region and anti-murine response of patients administered <sup>177</sup>Lu-CC49**

Patient	<u>µg of Ab/ml Sera</u>		
	Post-Mab Injection	BL-3 <sup>a</sup>	HuCC49 <sup>b</sup>
EA	0	0	0
	3 weeks	4.1	0.3
	6 weeks	289.0	2.3
	8 weeks	314.4	21.6
CP	0	0	0
	3 weeks	16.0	0.8
	5 weeks	25.2	0.7
	6 weeks	23.2	0.7
LQ	0	0	ND
	3 weeks	4.61	0.4
	6 weeks	6.64	0.7
	8 weeks	ND	1.7
JG	0	0	0
	3 weeks	58.6	0.7
	6 weeks	47.8	2.6

Competition Radioimmunoassay

To confirm whether the HAVRA was actually an anti-idiotypic response, including internal image anti-idiotypic antibodies, to the murine MAb CC49, the sera from one patient (EA) was selected and assessed for blocking of the binding of <sup>125</sup>I-HuCC49 to BSM in a radioimmunoassay.

The immunoreactivity of the radiolabeled MAbs was assessed using bovine submaxillary mucin (BSM) immobilized on a solid support (Reacti-Gel HW65, Pierce) as a modification of the method reported by Heam et al. (1979), J. Chromatog., 185:463-470 and Schott (1992) Cancer Res., 52:6413-6417. Briefly, bovine submaxillary mucin (BSM), which is TAG-72 positive, was adsorbed to each well of a 96-well polyvinylchloride microtiter plate at 10 ng in 50µl of phosphate buffered saline (pH 7.2) as described by Horan Hand et al. (1992), Cancer Immunol. Immunother., 353:165-174. After treating the wells with 5% BSA in PBS, serial dilutions of the patient sera (25µl in 1% BSA in PBS) were added to each; <sup>125</sup>I-CC49 (38 nCi in 25 µl) was also added. Following an 18 hour incubation at 4°C, the plates were washed and the wells counted in a γ-scintillation counter. The percent inhibition was calculated and compared to that of unlabeled CC49. Human IgG (Organon Teknika, Durham, NC), which does not react with TAG-72 was included as a control antibody.

It was found that the patient sera could block the binding of <sup>125</sup>I-HuCC49 with BSM (FIG. 22) suggesting that the patient, in actuality, demonstrates an anti-idiotypic response, consisting of the internal image anti-idiotypic antibodies. Furthermore, the anti-idiotypic response was observed to increase over an eight week period. Figure 22 shows the detection of patient (EA) anti-idiotypic antibody response to murine CC49: pre-study sera from patient EA (□); sera collected at 3 weeks (A), 6 weeks (B), and 8 weeks (C).

All references cited in this disclosure are hereby incorporated by reference.



**WHAT IS CLAIMED IS:**

1. A humanized anti-TAG-72 antibody comprising:  
light chain Complementarity Determining Regions (L-CDRs), comprising L-CDR1, L-CDR2 and L-CDR3; and heavy chain Complementarity Determining Regions (H-CDRs), comprising H-CDR1, H-CDR2 and H-CDR3,  
wherein L-CDR3, H-CDR1, H-CDR2 and H-CDR3 are from a non-human antibody and at least one of L-CDR1 and L-CDR2 are human antibody sequences.
2. The humanized antibody of claim 1, wherein L-CDR1 is from a human antibody.
3. The humanized antibody of claim 2, wherein L-CDR1 is from human monoclonal antibody LEN.
4. The humanized antibody of claim 1, wherein L-CDR2 from a human antibody.
5. The humanized antibody of claim 4, wherein L-CDR2 is from human monoclonal antibody LEN.
6. The humanized antibody of claim 1, wherein both L-CDR1 and L-CDR2 are human antibody sequences.
7. The humanized antibody of claim 1, wherein L-CDR1 and L-CDR2 are human antibody sequences from the same human antibody.
8. The humanized antibody of claim 7, wherein L-CDR1 and L-CDR2 are human antibody sequences from human monoclonal antibody LEN.
9. The humanized antibody of claim 6, wherein L-CDR1 and L-CDR2 are human antibody sequences from different human antibodies.

10. The humanized antibody of claim 1, wherein L-CDR3, H-CDR1, H-CDR2 and H-CDR3 are from murine monoclonal antibody CC49.
11. A humanized anti-TAG-72 antibody comprising:  
light chain Complementarity Determining Regions (L-CDRs), comprising L-CDR1, L-CDR2 and L-CDR3; and heavy chain Complementarity Determining Regions (H-CDRs), comprising H-CDR1, H-CDR2 and H-CDR3,  
wherein at least one amino acid of positions 60, 61, 62, or 64 in H-CDR2 is replaced with a corresponding amino acid from a human antibody.
12. The humanized antibody of claim 11, wherein the human antibody is 21/28'CL.
13. The humanized antibody of claim 11, wherein the amino acid at position 97 of L-CDR3 is replaced with a corresponding amino acid from a human antibody.
14. The humanized antibody of claim 11, wherein at least one of L-CDR1 and L-CDR2 are human antibody sequences.
15. The humanized antibody of claim 14, wherein L-CDR1 is a human antibody sequence.
16. The humanized antibody of claim 15, wherein L-CDR1 is from human monoclonal antibody LEN.
17. The humanized antibody of claim 14, wherein L-CDR2 is a human antibody sequence.
18. The humanized antibody of claim 17, wherein L-CDR2 is from human monoclonal antibody LEN.

19. The humanized antibody of claim 17, wherein both L-CDR1 and L-CDR2 are human antibody sequences.
20. The humanized antibody of claim 19, wherein L-CDR1 and L-CDR2 are human antibody sequences from the same human antibody.
21. The humanized antibody of claim 20, wherein L-CDR1 and L-CDR2 are from human monoclonal antibody LEN.
22. The humanized antibody of claim 19, wherein L-CDR1 and L-CDR2 are human antibody sequences from different human antibodies.
23. A humanized anti-TAG-72 antibody comprising:  
    light chain Complementarity Determining Regions (L-CDRs),  
    comprising L-CDR1, L-CDR2 and L-CDR3; and heavy chain  
    Complementarity Determining Regions (H-CDRs), comprising H-CDR1,  
    H-CDR2 and H-CDR3,  
    wherein an amino acid at position 97 of L-CDR3 is replaced with a  
    corresponding amino acid from a human antibody.
24. The humanized antibody of claim 23, wherein at least one amino acid of positions 60, 61, 62, or 64 in H-CDR2 is replaced with a corresponding amino acid from a human antibody.
25. The humanized antibody of claim 23, wherein at least one of L-CDR1 and L-CDR2 are human antibody sequences.
26. The humanized antibody of claim 25, wherein L-CDR1 is a human antibody sequence.
27. The humanized antibody of claim 26, wherein L-CDR1 is from human monoclonal antibody LEN.

28. The humanized antibody of claim 25, wherein L-CDR2 is a human antibody sequence.
29. The humanized antibody of claim 28, wherein L-CDR2 is from human monoclonal antibody LEN.
30. The humanized antibody of claim 25, wherein both L-CDR1 and L-CDR2 are from human antibody sequences.
31. The humanized antibody of claim 30, wherein L-CDR1 and L-CDR2 are human antibody sequences from the same human antibody.
32. The humanized antibody of claim 31, wherein L-CDR1 and L-CDR2 are from human antibody sequences from human monoclonal antibody LEN.
33. The humanized antibody of claim 30, wherein L-CDR1 and L-CDR2 are human antibody sequences from different human antibodies.
34. A humanized anti-TAG-72 antibody comprising:
  - light chain Complementarity Determining Regions (L-CDRs), comprising L-CDR1, L-CDR2 and L-CDR3; and heavy chain Complementarity Determining Regions (H-CDRs), comprising H-CDR1, H-CDR2 and H-CDR3,
  - wherein residues at positions 94 and 97 in L-CDR3 are from a non-human anti-TAG-72 antibody.
35. A humanized anti-TAG-72 antibody comprising:
  - light chain Complementarity Determining Regions (L-CDRs), comprising L-CDR1, L-CDR2 and L-CDR3; and heavy chain Complementarity Determining Regions (H-CDRs), comprising H-CDR1, H-CDR2 and H-CDR3,
  - wherein residues at positions 31, 32 and 34 in H-CDR1 are from a non-human anti-TAG-72 antibody.

36. A nucleic acid sequence expressing the humanized antibody of any of claims 1, 11, 23, 34 or 35.
37. A vector expressing the humanized antibody of any of claims 1, 11, 23, 34 or 35.
38. A composition for treatment of cancer, comprising the humanized antibody of any of claims 1, 11, 23, 34 or 35.
39. A composition for detecting cancer cells, comprising the humanized antibody of any of claims 1, 11, 23, 34 or 35.
40. A composition of for detecting cancer cells, comprising a polypeptide capable of specifically binding TAG-72, said polypeptide comprising a functional fragment of the humanized antibody of any of claims 1, 11, 23, 34 or 35.
41. The composition of claim 40, wherein the polypeptide comprises a fragment selected from the group consisting of Fv, Fab, and F(ab')<sub>2</sub>.
42. A method for treating cancer comprising:  
administering the humanized antibody of any of claims 1, 11, 23, 34 or 35 to a patient.
43. A method of detecting cancer cells, comprising:  
contacting cells with the humanized antibody of any of claims 1, 11, 23, 34 or 35.
44. The method of claim 43, wherein the humanized antibody is labeled.
45. The method of claim 43, wherein the humanized antibody is detected using a labeled secondary antibody.

46. A method of detecting cancer cells, comprising:  
    contacting cells with composition comprising a polypeptide capable of specifically binding TAG-72, said polypeptide comprising a functional fragment of the humanized antibody of any of claims 11, 11, 23, 34 or 35.
47. The method of claim 46, wherein the polypeptide comprises a fragment selected from the group consisting of Fv, Fab, and F(ab')<sub>2</sub>.

FIG. 1

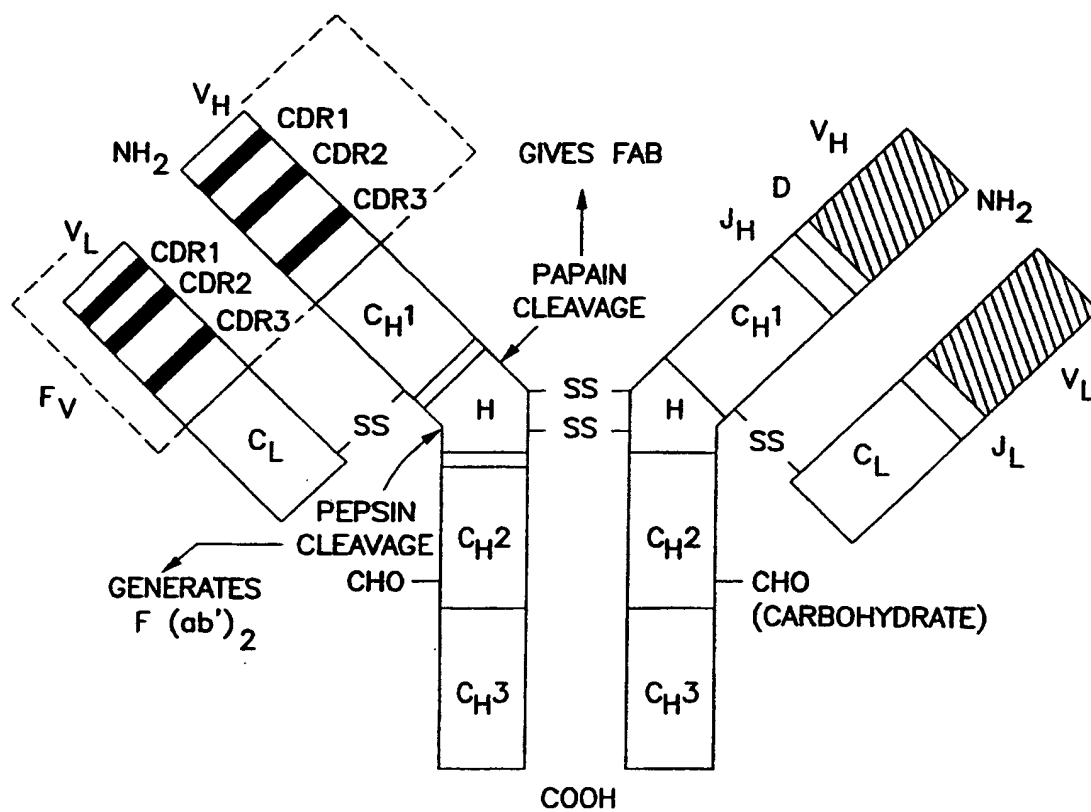

FIG. 2

Light chain	
CDR 1 HuCC49 LEN	24 Lys 25 Ser 26 Ser 27 Gln 27 Gln 28 Tyr 29 Gln 30 Lys 31 Asn 32 Tyr 33 Leu 34 Ala
CDR 2 HuCC49 LEN	50 Trp 51 Ala 52 Ser 53 Ala 54 Arg 55 Glu 56 Ser
CDR 3 HuCC49 LEN	89 Gln 90 Gln 91 Tyr 92 Tyr 93 Ser 94 Thr 95 Pro 96 Leu 97 Thr
Heavy chain	
CDR 1 HuCC49 21/28'CL	31 Asp 32 His 33 Ala 34 Ile 35 His
CDR 2 HuCC49 21/28'CL	50 Tyr 51 Phe 52 Ser 53 Pro 54 Asn 55 Asp 56 Asp 57 Phe 58 Lys 59 Tyr 60 Asn 61 Glu 62 Arg 63 Phe 64 Lys 65 Gly
CDR 3 HuCC49 21/28'CL	95 Ser 96 Leu 97 Asn 98 Met 99 Ala 100 Ser 101 Tyr 102 Tyr



FIG. 3

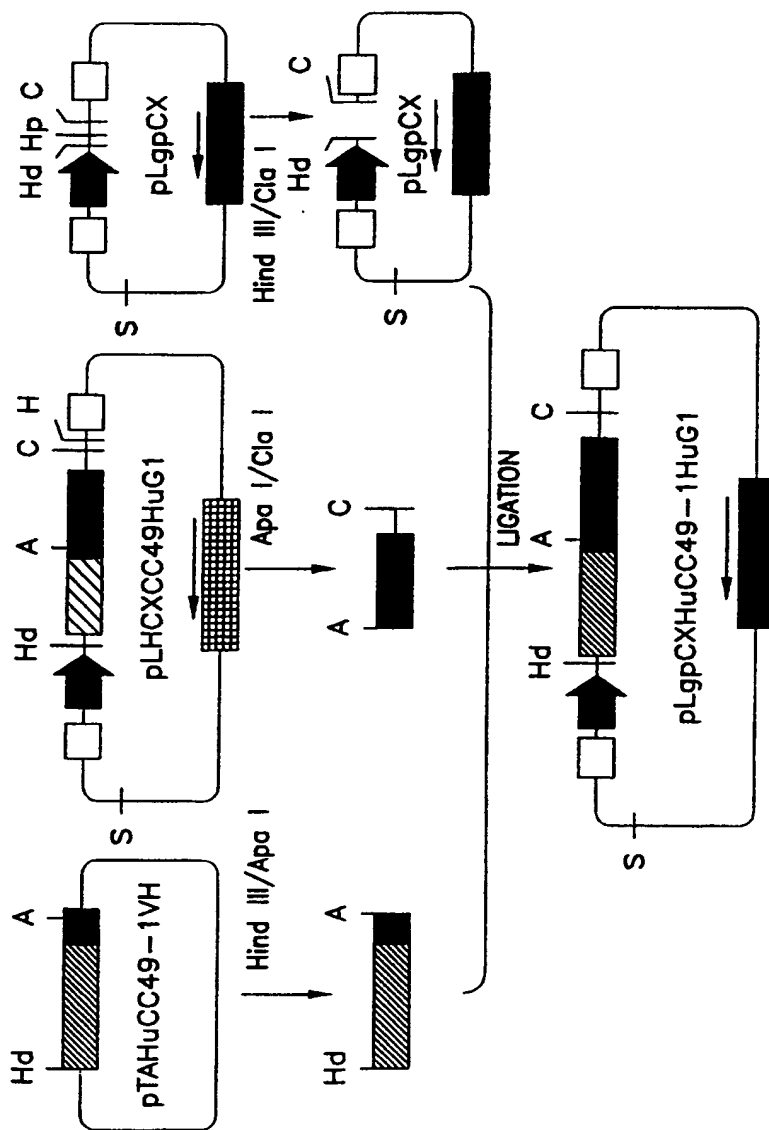

FIG. 4

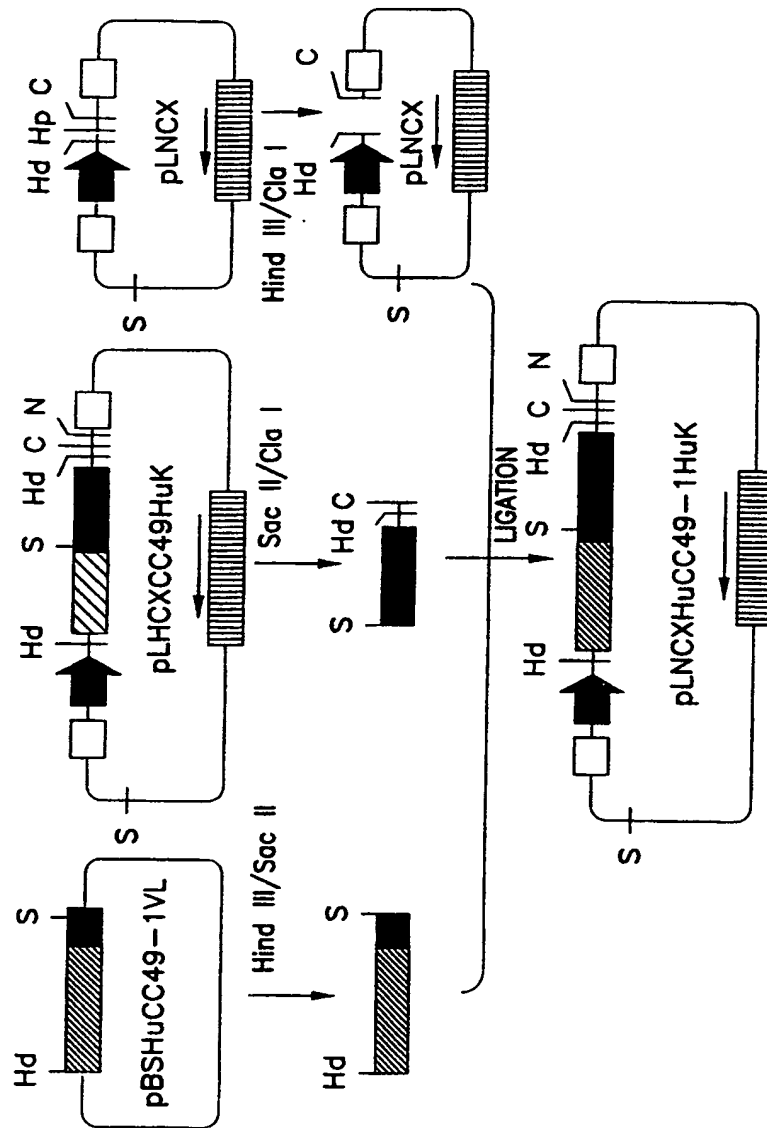
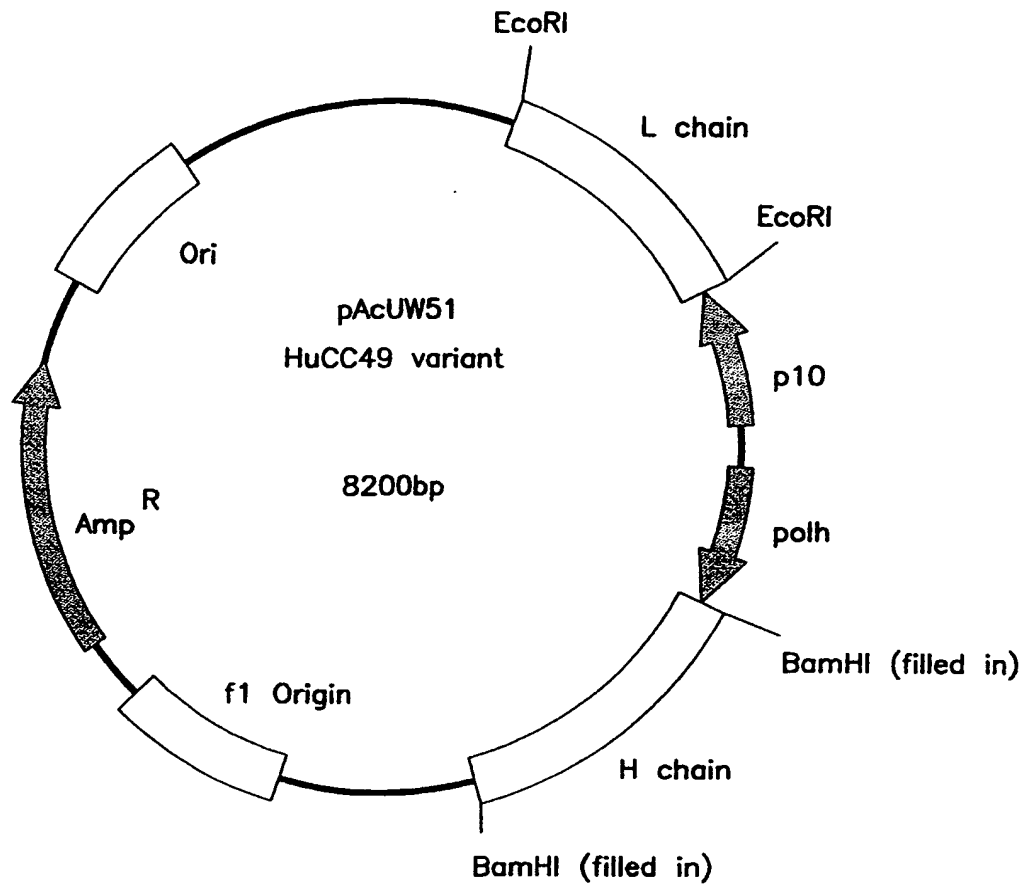
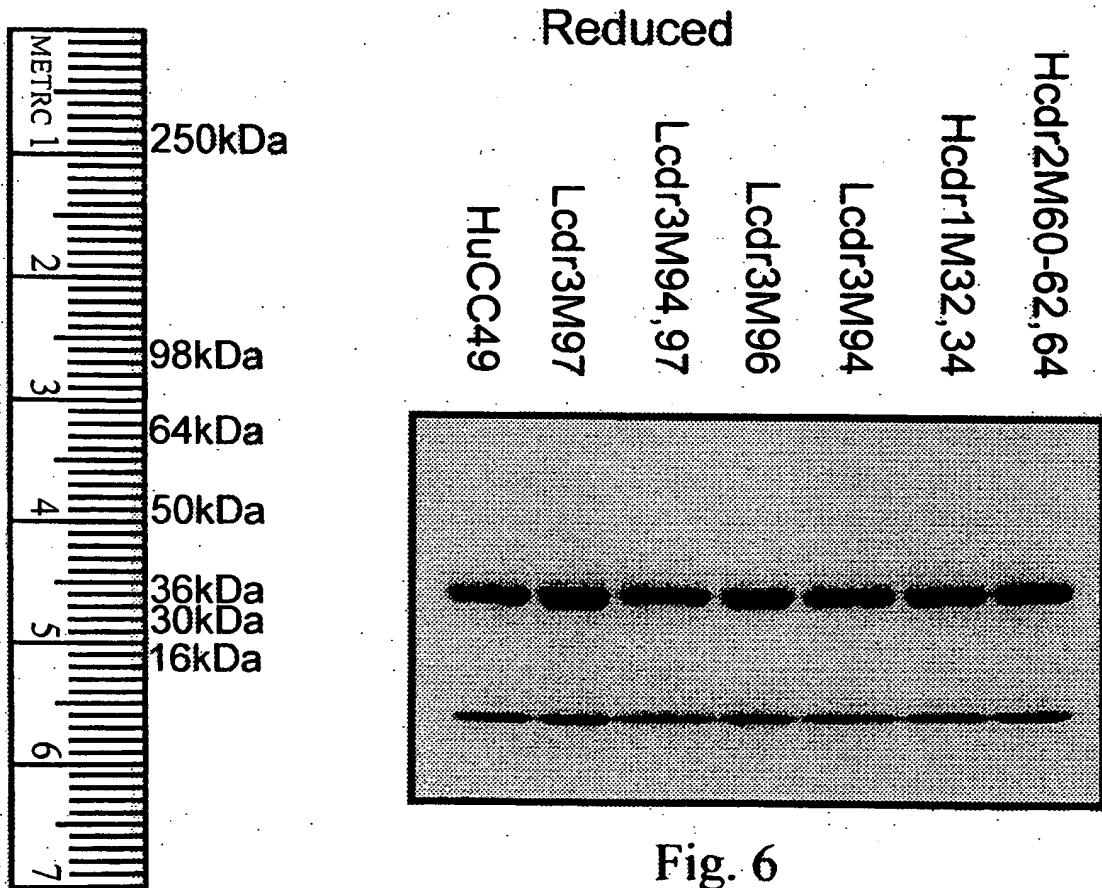

FIG. 5





7/23

FIG. 7

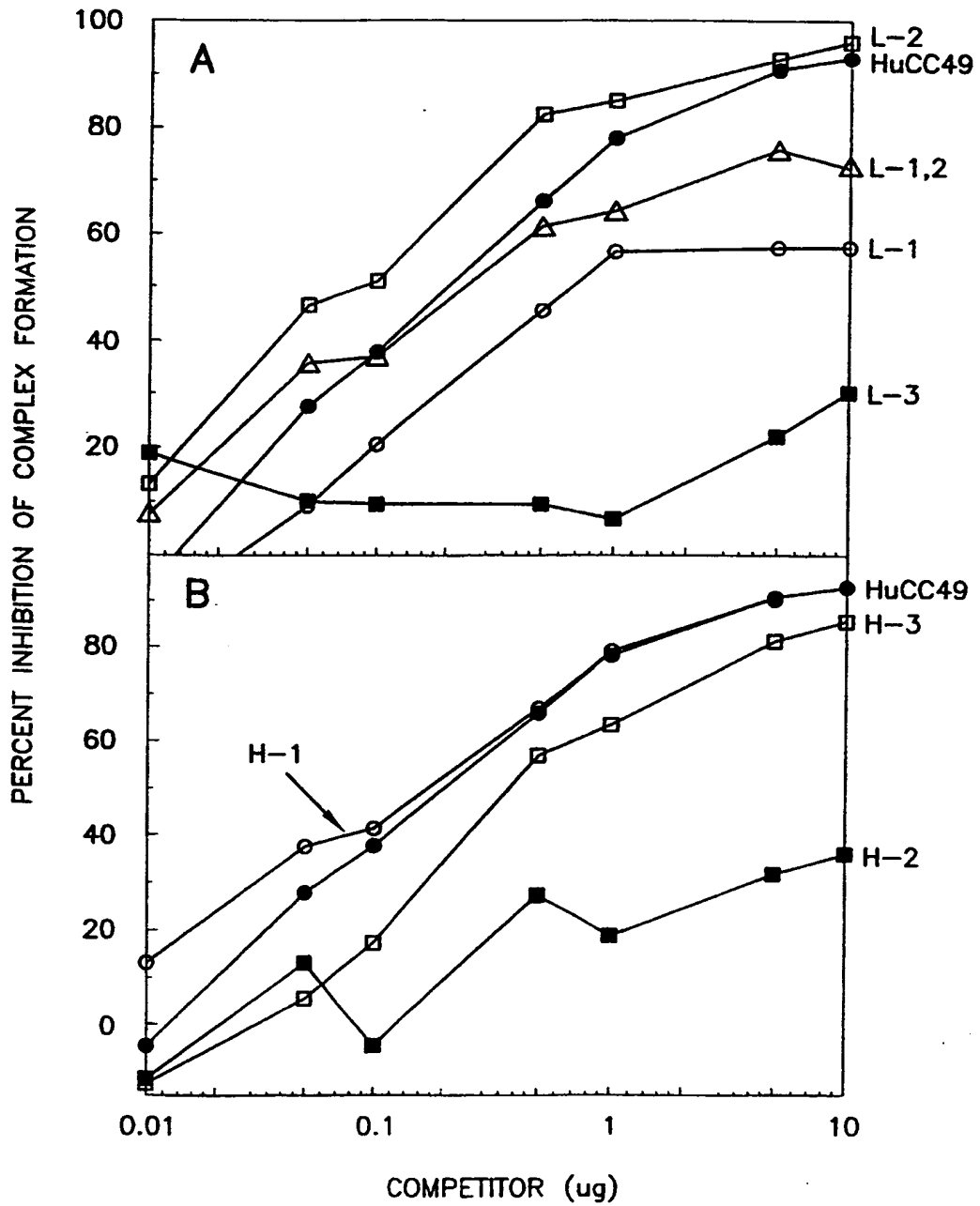

8/23

FIG. 8

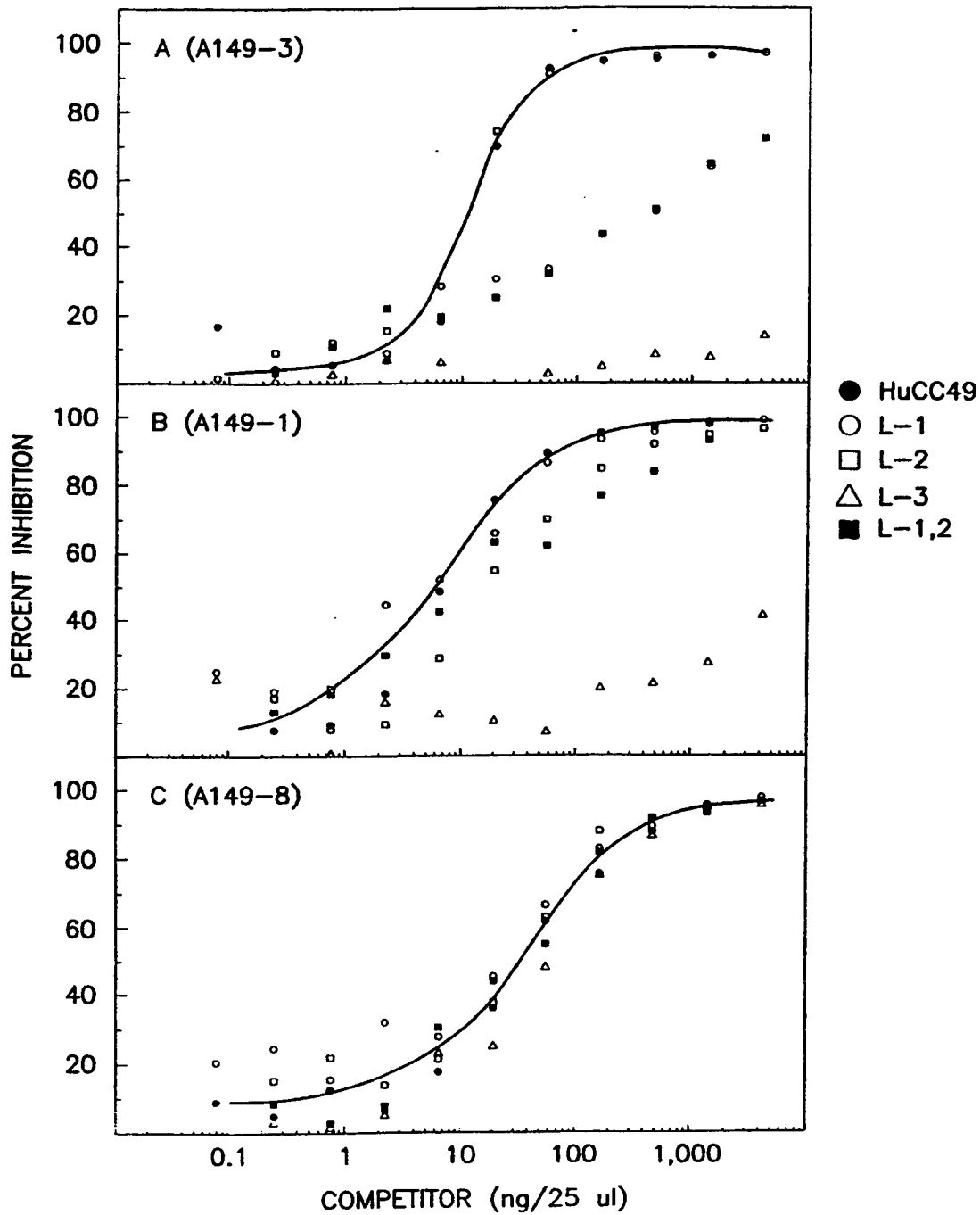

9/23

FIG. 9

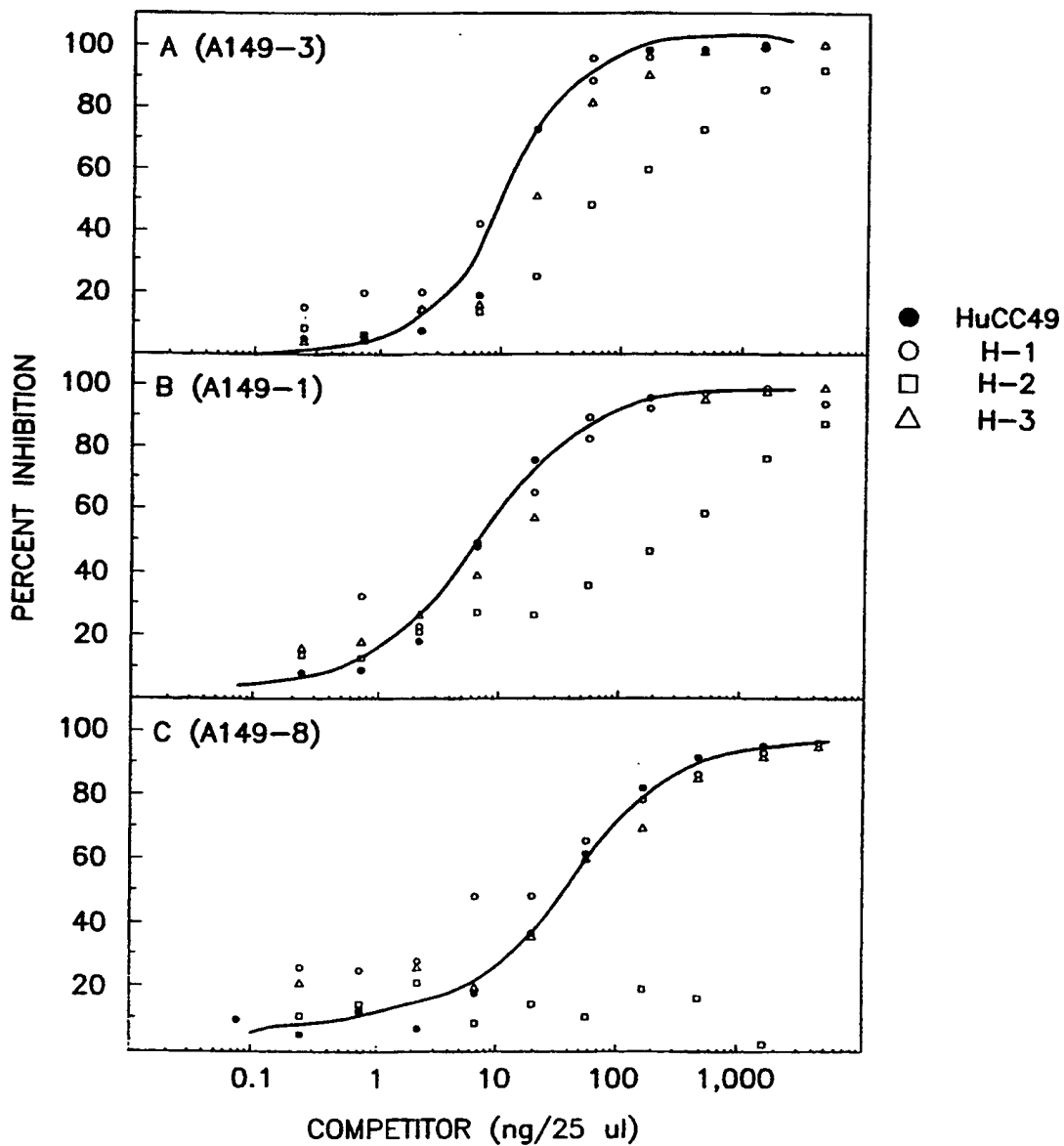

10/23

FIG. 10

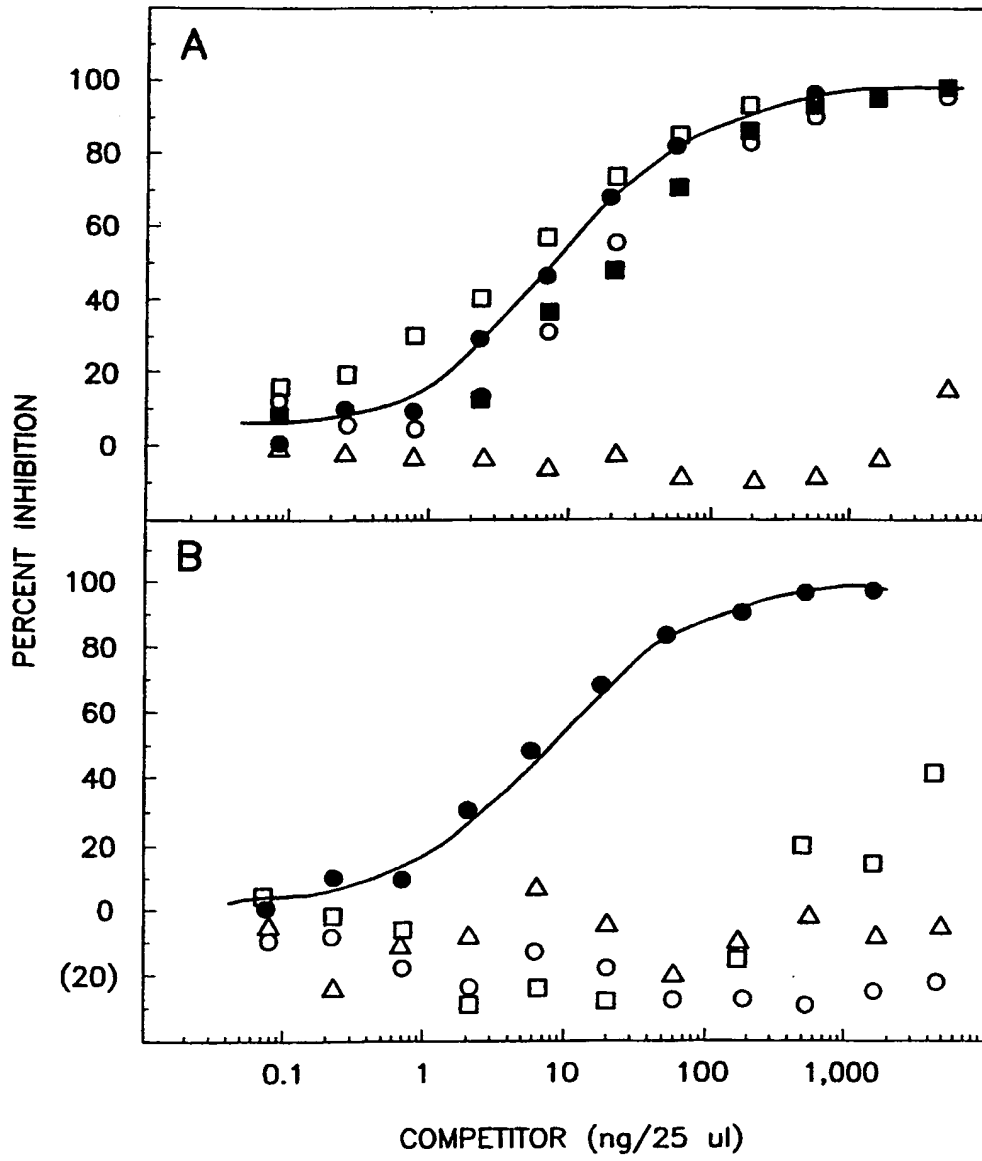



FIG. 11

**A.**

..... . . . . CDR1 .....  
 DIVMTQSPDSLAVSLGERATINC WYQKPKGQPPKLLIY  
 DIVMSQSPDSLAVSLGERVTLNC KSSQSLLYSGNQKNYLA WYQKPKGQSPKLLIY  
 CDR2 . . . . . CDR3 . . . . .  
 GVPDRFSGSGGTDFTLTISLQAEDVAVYYC FGQGTKLEIK  
 WASARES GVPDRFSGSGGTDFTLTISLQAEDVAVYYC QYYSYPLT FGAGTKLELK

**B.**

..... . . . . CDR1 .....  
 QVQLVQSGAEVKKPGASVKVSCKASGYTFT WVRQAPGQRLEWMG  
 QVQLVQSGAEVVKPGASVKISCKASGYTFT DHAIH WVKQNPGRLEWIG  
 CDR2 . . . . .  
 RVTITRDTASASTAYMELSSLRSEDTAVYYCAR  
 YFSPGNDDFKYNERFKG KATLTADTSASTAYVELSSLRSEDTAVYFCTR  
 CDR3 . . . . .  
 WGQGILVTVSS  
 SLNMAY WGQGLTVTVSS

LEN HuCC49

LEN HuCC49

21/28'CL HuCC49

21/28'CL HuCC49

21/28'CL HuCC49

12/23

FIG. 12A

A.

1 1 60  
gcaagctccaccATGGATAGCCAGGCCAGGTGCTCATGCTCCCTGCTGCTGCTGGGTGAG  
-----+-----+-----+-----+-----+-----+-----+  
cgtcgagggtgTACCTATCGGTCGGGTCCACGAGTACGAGGACGACGACACCCACTC  
  
61 120  
CGGCACATGCCGGCGACATCGTGATGAGCCAGTCTCCAGACTCCCTGGCCGTGTCCCAGGG  
-----+-----+-----+-----+-----+-----+-----+  
GCCGTGTACGCCCGCTGTAGCACTACTCGGTACAGAGTCTGAGGGACCGGCACAGGGACCC  
  
121 180  
CGAGAGGGTGACTCTGAATTGCAAGTCCAGCCAGTCCCTGCTCTATAGCGGAAATCAGAA  
-----+-----+-----+-----+-----+-----+-----+  
GCTCTCCCACTGAGACTTAACGTTACAGTTCAGGTCAGGACGAGATATCGCCTTTAGTCTT  
  
181 240  
GAACTATCTCGCCTGGTATCAGCAGAAACCAGGGCAGAGCCCTAAACTGCTGATTTACTG  
-----+-----+-----+-----+-----+-----+-----+  
CTGTAGAGCCGGACCATAGTCGCTTTGGTCCCGTCTCGGGATTTGACGACTAATGAC  
  
241 300  
GGCATCCCGCTAGGGAATCCGGCGGTGCCTGATCGCTTCAGCCGGCAGCGGATCTGGGACAGA  
-----+-----+-----+-----+-----+-----+-----+  
CCGTAGGCCGATCCCTTAGGCCGCCACGGACTAGCGAAGTCCCGTCCGCTAGACCCCTGTCT  
  
301 360  
CTTCACTCTGACAAATCAGCAGCGGTGCAGGCAGAAAGACGTGGCAGTCTATTATTGTCAGCA  
-----+-----+-----+-----+-----+-----+-----+  
GAAGTGAGACTGTTAGTCGTCCGACGTCCTTCTGCCACCGTCAGATAATAACAGTCGT  
  
361 420  
GTATTATAGCTATCCCCTCACATTCGGCGCTGGCACCAAGCTGGAACGAAcggccg c  
-----+-----+-----+-----+-----+-----+-----+  
CATAATATCGATAGGGGAGTGTAAGCCCGGACCGGTGGTTGACCTTGACTTTgccccg c g c g c g

421 424  
ggct  
-----  
ccga

FIG. 12B

B.

1 ct a a g c t t c c a c c a t g g a g t g g t c c t g g g t c t t c c t c t t c c t c c t g c t g c t g t g g g t g a g  
 60 g a t t c g a a g g t g g t a c c t c a c c a g g a c c c a g a a g g a g a g g a c c g a c c a c c a c c a c t c  
 120 a g t g c a c t c c c a g g t c c a g c t g g t g c a g t c c g g c g c t g a g t c c c t g c c c g t g t c c c a g g g  
 180 t c a c g t g a g g g t c c a g g t c g a c c a c g t c a g g c c g c g a c t c a g g a c c g g c a c a g g g a c c c  
 240 c g t g a a g a t t c c t g c a a g g c a a g c g g c t a c a c c t t c a c t c t c t a t a g c g g a a a t c a g a a  
 300 g c a c t t c t a a a g g a c g t t c c g t t c g c c g a t g t g g a a g t g a g a g a t a t c g c c t t t a g t c t t  
 360 g a a c a g a a t c c t g g a c a c g c c t g g a g t g g a t t g g a t a t t t c t c t c c c g g a a a c g a t g a  
 420 c t t t g t c t t a g g a c c t g t c g c g g a c c t c a c c t a a c c t a t a a g a g a g g c c t t t g c t a c t  
 480 t t t t a a g t a c a a t g a g a g g t t c a a g g g c a a g g c c a c a c t g a c t g c a g a c a c a t c t g c c c a g  
 540 a a a t t c a t g t t a c t c t c c a a g t t c c c g t t c c g g t g t g a c t g a c g t c t g t g t a g a c g g t c  
 600 c a c t g c c t a c g t g g a g c t c t c c a g c c t g a g a t c c g a g g a t a c t g c a g t g t a c t t c t g c a c  
 660 g t g a c g g a t g c a c c t c g a g a g g t c g g a c t c t a g g c t c c t a t g a c g t c a c a t g a a g a c g t g  
 720 a a g a t c c c t g a a t a t g g c c t a c t g g g g a c a g g a a c c c t g g t c a c c g t c t c c a g c g c c a a  
 780 t t c t a g g g a c t t a t a c c g g a t g a c c c t g t c c c t t g g a c c a g t g c a g a g g t c g c g g t t  
 840 a a c t a c g g g c c c a t 434  
 900 t t g a t g c c c g g g t a

FIG. 13

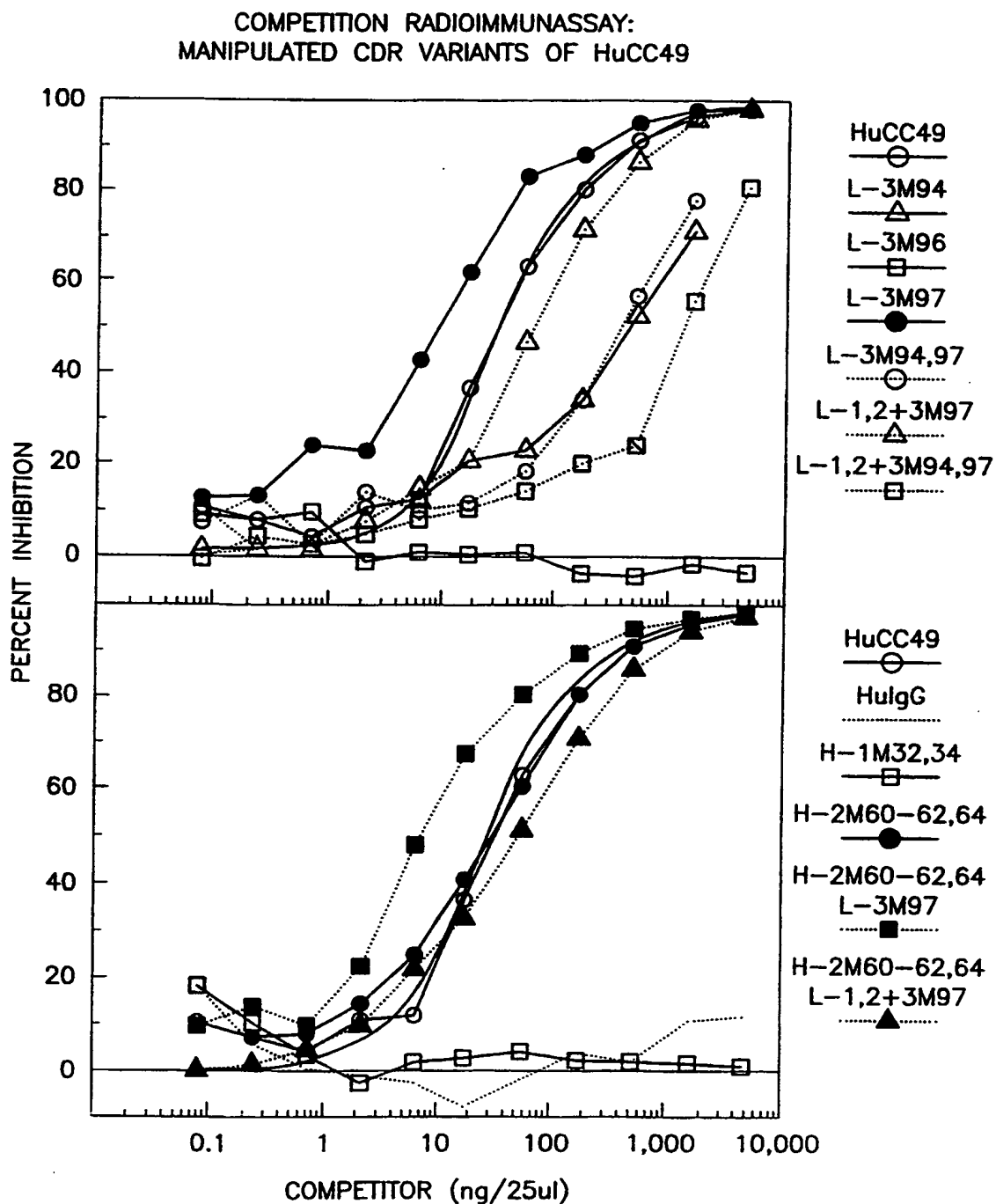

15/23

FIG. 14

HPLC ANALYSIS OF PATIENT REACTIVITY TO CDR SUBSTITUTION  
VARIANTS OF HuCC49

	COMPETITOR		PATIENTS			
	CDR SUBSTITUTIONS	ANTIGEN BINDING	DG	CP	EA	DS
NONE	----		46.2 <sup>b</sup>	32.2	56.8	33.5
HuCC49	----	+++	0	1.5	0.5	0
HuIgG	----	-	59.0	N.D.	63.6	46.4
LIGHT	L3M94	+/-	30.2	20.3	16.4	28.9
	L3M96	-	39.2	31.1	42.9	35.2
	L3M97	+++	0.6	1.3	0.7	2.4
	L3M94,97	+/-	26.5	18.2	18.6	25.6
	L1,2+3M97	++	21.3	17.6	23.8	17.1
	L1,2+3M94,97	+	53.2	38.1	44.2	37.3
HEAVY	1M32,34	-	1.4	5.5	3.8	0.7
	2M60-62,64	++	24.4	17.9	21.8	16.5
BOTH	L3M97	++++	13.0	16.1	3.9	20.1
	H2M60-62,64					
	L1,2+3M97	++	33.0	30.7	24.9	32.1
H2M60-62,64						

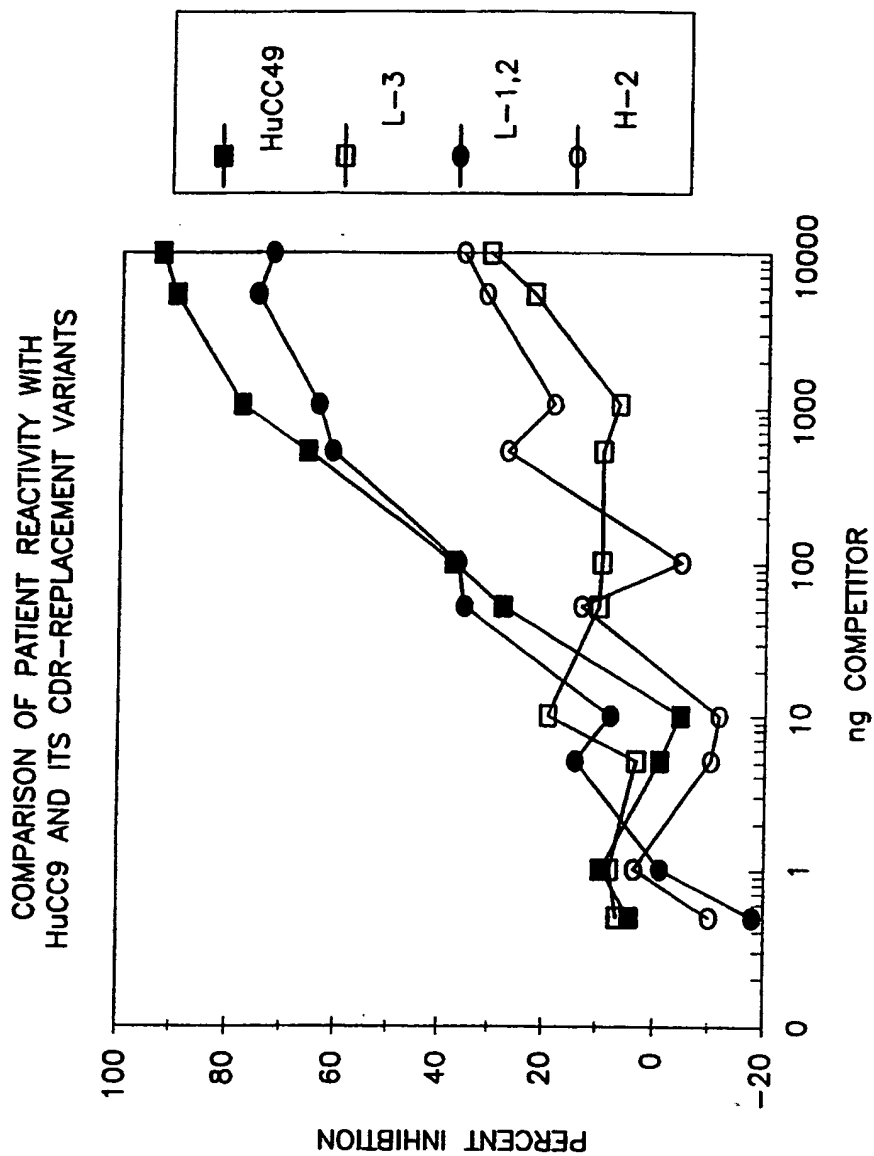

FIG. 15

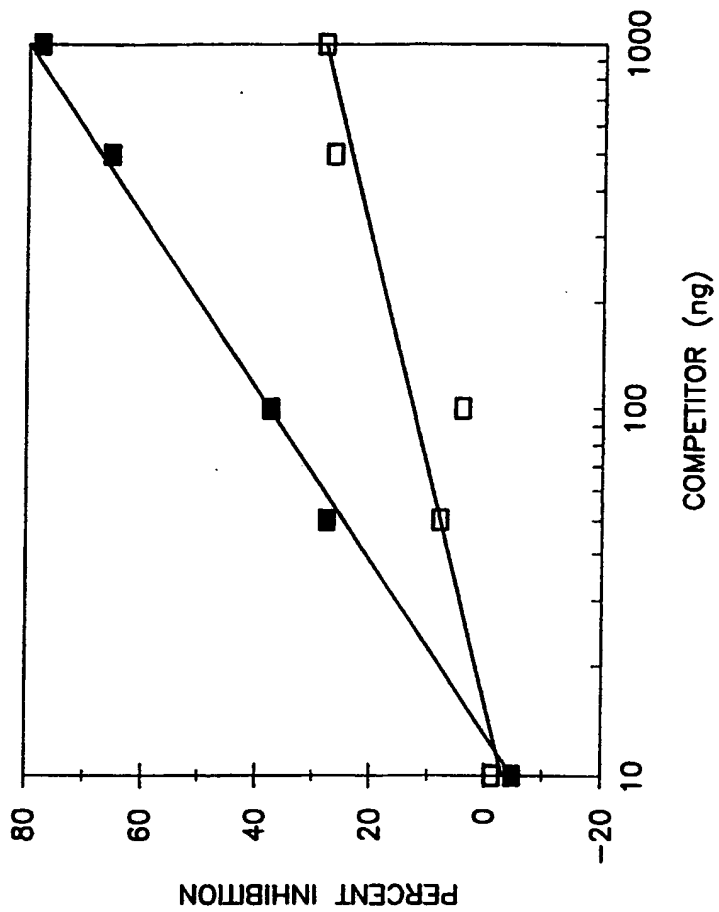

FIG. 16

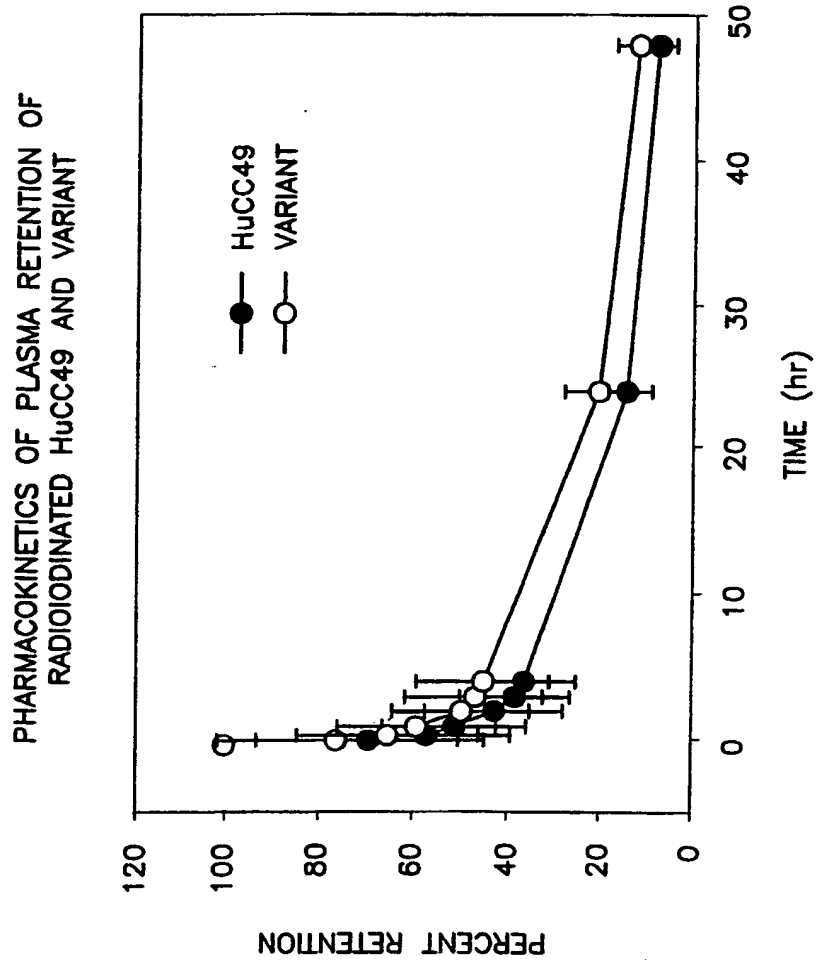

FIG. 17



19/23

FIG. 18

BIODISTRIBUTION OF I.V. ADMINISTERED RADIOLABELED HuCC49 AND VARIANT IN ATHYMIC MICE BEARING LS-174T HUMAN COLON CARCINOMA XENOGRAFTS: PERCENT OF INJECTED DOSE/GRAM

ANTIBODY	ORGAN	TIMEPOINTS (hr)				
		24	48	72	120	168
VARIANT	TUMOR	15.83	23.75	21.01	17.74	9.21
	BLOOD	6.35	4.93	4.88	2.19	0.63
	LIVER	3.39	2.14	1.46	0.91	0.32
	SPLEEN	5.90	6.04	2.55	2.43	3.96
	KIDNEY	2.52	1.27	1.00	0.77	0.36
	LUNG	3.22	2.57	2.50	1.12	0.36
HuCC49	TUMOR	11.86	17.59	15.31	13.75	5.24
	BLOOD	4.17	2.94	2.85	1.29	0.18
	LIVER	4.77	3.05	1.41	0.70	0.12
	SPLEEN	6.41	7.47	2.28	2.00	0.46
	KIDNEY	1.86	0.92	0.70	0.57	0.14
	LUNG	2.17	1.58	1.46	0.68	0.12

FIG. 19

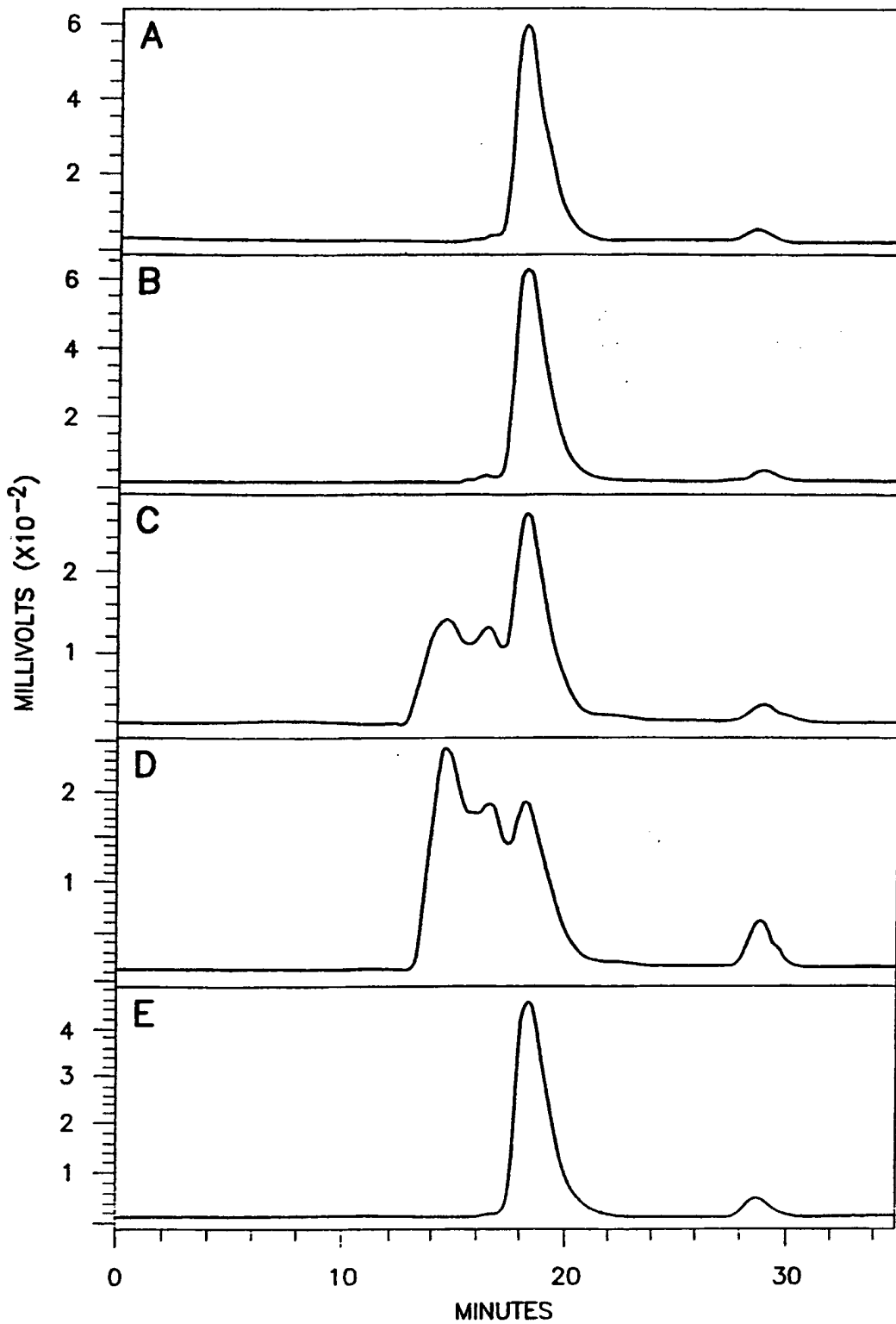
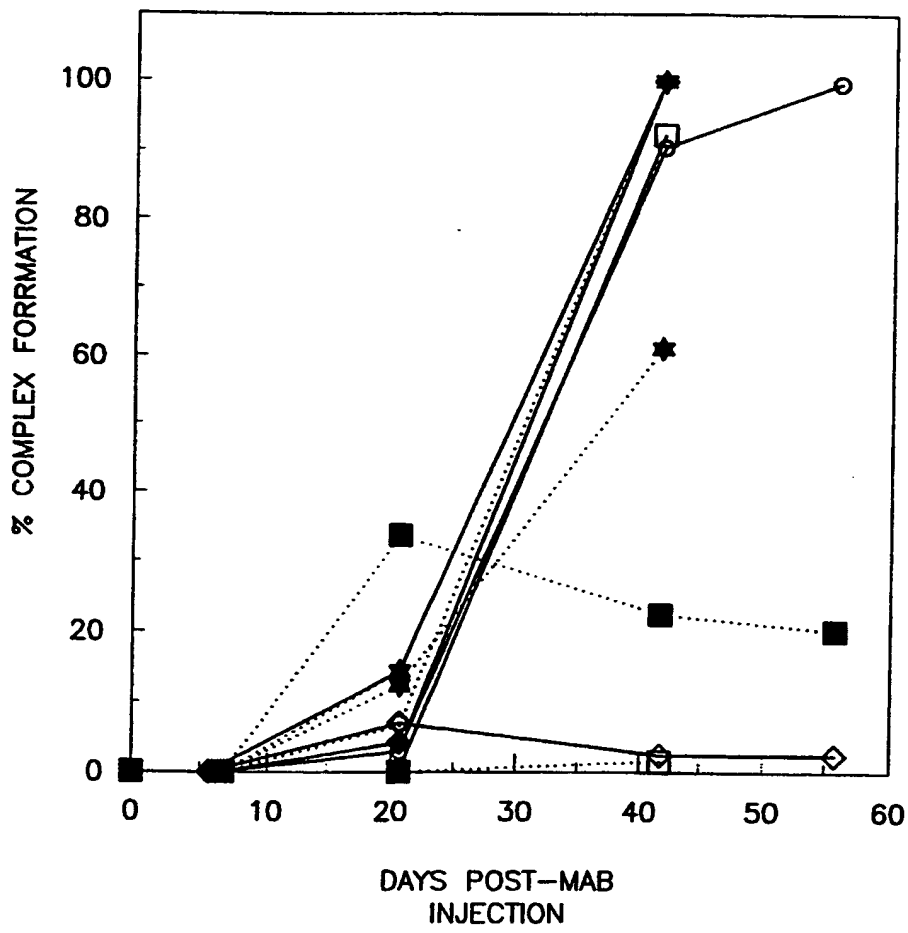

FIG. 20



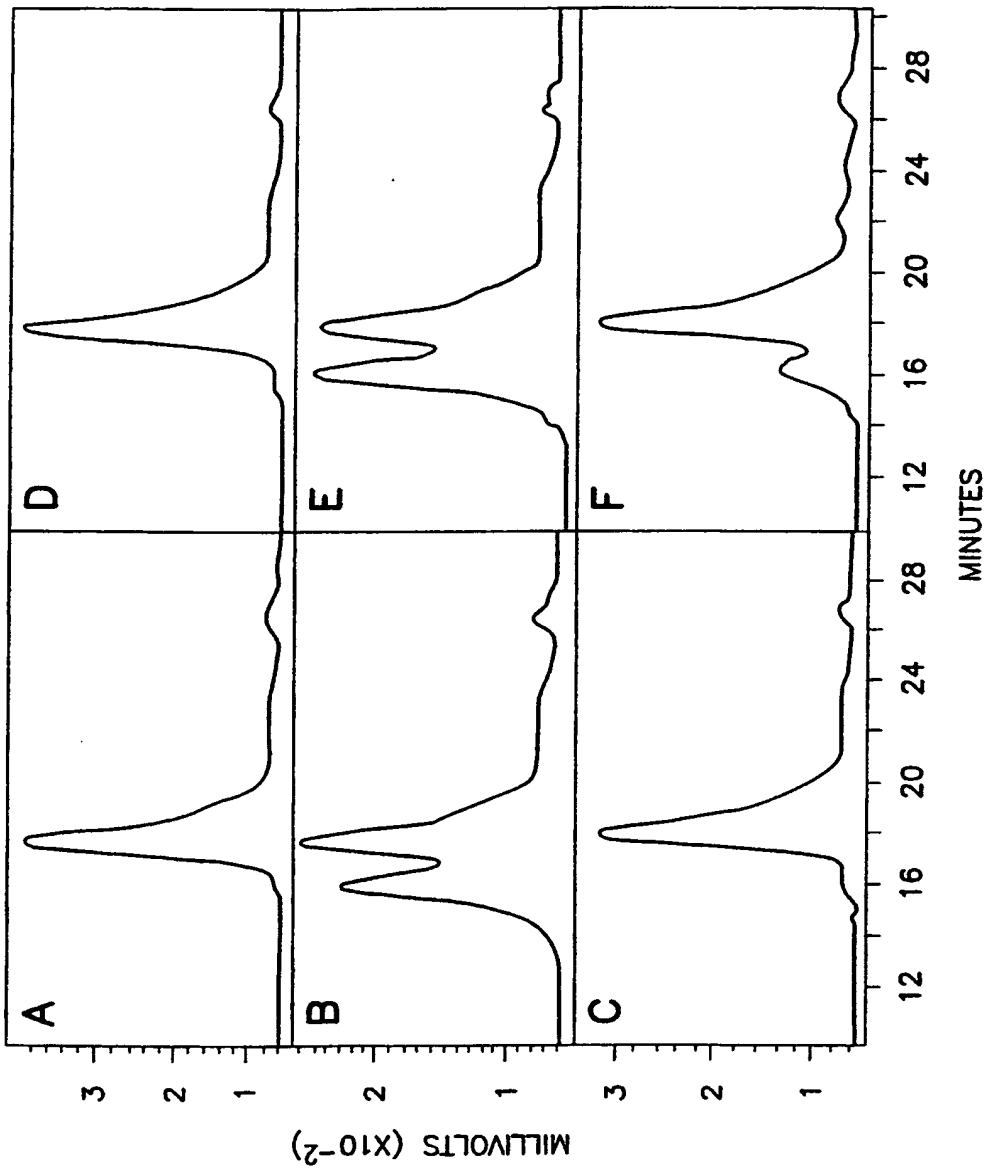
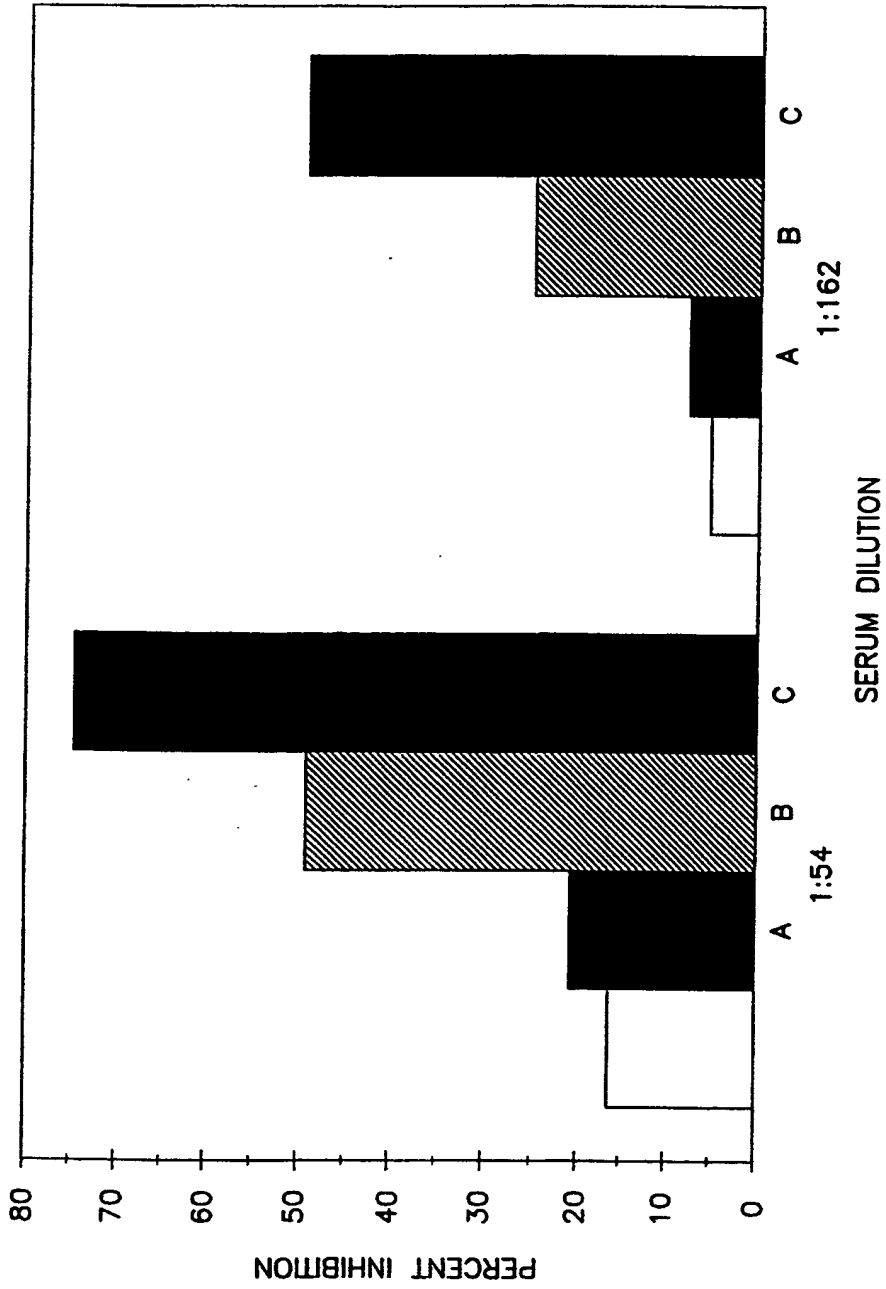

FIG. 21

FIG. 22



# INTERNATIONAL SEARCH REPORT

Intern. Appl. No.

PCT/US 99/25552

<b>A. CLASSIFICATION OF SUBJECT MATTER</b> IPC 7 C12N15/85 C12N15/62 C12N5/10 C07K16/30 C07K16/46 A61K51/10 A61P35/00 G01N33/574 A61K39/395		
According to International Patent Classification (IPC) or to both national classification and IPC		
<b>B. FIELDS SEARCHED</b> Minimum documentation searched (classification system followed by classification symbols) IPC 7 C07K		
Documentation searched other than minimum documentation to the extent that such documents are included in the fields searched		
Electronic data base consulted during the international search (name of data base and, where practical, search terms used)		
<b>C. DOCUMENTS CONSIDERED TO BE RELEVANT</b>		
Category	Citation of document, with indication, where appropriate, of the relevant passages	Relevant to claim No.
X	Y SHA ET AL: "A heavy-chain grafted antibody that recognizes the tumor-associated TAG72 antigen" CANCER BIOTHERAPY, vol. 9, no. 4, 1 January 1994 (1994-01-01), pages 341-349, XP002079337 abstract page 342, left-hand column, paragraph 2 -right-hand column, paragraph 1 page 346, left-hand column, paragraph 2 -page 347, right-hand column, paragraph 1	1-47
X	WO 97 26010 A (SMITHKLINE BEECHAM CORP., USA;UNIVERSITY OF VERMONT AND STATE AGRICULT) 24 July 1997 (1997-07-24) page 9, line 28 -page 10, line 10 page 21, line 25 -page 22, line 13 -/-	1,2,4,6, 7,9, 36-41
<input checked="" type="checkbox"/> Further documents are listed in the continuation of box C.		
<input checked="" type="checkbox"/> Patent family members are listed in annex.		
* Special categories of cited documents :		
*A* document defining the general state of the art which is not considered to be of particular relevance *E* earlier document but published on or after the international filing date *L* document which may throw doubts on priority claim(s) or which is cited to establish the publication date of another citation or other special reason (as specified) *O* document referring to an oral disclosure, use, exhibition or other means *P* document published prior to the international filing date but later than the priority date claimed		
*T* later document published after the international filing date or priority date and not in conflict with the application but cited to understand the principle or theory underlying the invention *X* document of particular relevance; the claimed invention cannot be considered novel or cannot be considered to involve an inventive step when the document is taken alone *Y* document of particular relevance; the claimed invention cannot be considered to involve an inventive step when the document is combined with one or more other such documents, such combination being obvious to a person skilled in the art. *Z* document member of the same patent family		
Date of the actual completion of the international search	Date of mailing of the international search report	
6 April 2000	20/04/2000	
Name and mailing address of the ISA European Patent Office, P.B. 5818 Patentlaan 2 NL - 2280 HV Rijswijk Tel. (+31-70) 340-2040, Tx. 31 651 epo nl, Fax: (+31-70) 340-3016	Authorized officer  Covone, M	

## INTERNATIONAL SEARCH REPORT

Intern. Application No

PCT/US 99/25552

C.(Continuation) DOCUMENTS CONSIDERED TO BE RELEVANT		
Category *	Citation of document, with indication, where appropriate, of the relevant passages	Relevant to claim No.
X	<p>DATABASE MEDLINE 'Online!  US NATIONAL LIBRARY OF MEDICINE (NLM),  BETHESDA, MD, US  XIANG J ET AL: "Complementarity  determining region residues aspartic acid  at H55, serine at H95 and tyrosines at H97  and L96 play important roles in the B72.3  antibody-TAG72 antigen interaction."  retrieved from STN  Database accession no. 97015918  XP002134981  abstract  &amp; PROTEIN ENGINEERING, (1996 JUN) 9 (6)  539-43. ,</p>	23,36-47
X	<p>DATABASE MEDLINE 'Online!  US NATIONAL LIBRARY OF MEDICINE (NLM),  BETHESDA, MD, US  XIANG J ET AL: "The tyrosine residue at  position 97 in the VH CDR3 region of a  mouse/human chimeric anti-colorectal  carcinoma antibody contributes hydrogen  bonding to the TAG72 antigen."  retrieved from STN  Database accession no. 95102752  XP002134982  abstract  &amp; CANCER BIOTHERAPY, (1993 FALL) 8 (3)  253-62. ,</p>	23,36-47
A	<p>WO 96 13594 A (US HEALTH)  9 May 1996 (1996-05-09)  page 24, line 9 -page 26, line 3  examples 13,17,18</p>	1-47
P,A	<p>WO 99 43816 A (ARMOUR KATHRYN ;CARR FRANK  J (GB); HARRIS WILLIAM J (GB); TEMPEST)  2 September 1999 (1999-09-02)  example 1  claims</p>	1-47
T	<p>DATABASE MEDLINE 'Online!  US NATIONAL LIBRARY OF MEDICINE (NLM),  BETHESDA, MD, US  IWAHASHI M ET AL: "CDR substitutions of a  humanized monoclonal antibody (CC49):  contributions of individual CDRs to  antigen binding and immunogenicity."  retrieved from STN  Database accession no. 2000162136  XP002134983  abstract  &amp; MOLECULAR IMMUNOLOGY, (1999 OCT-NOV) 36  (15-16) 1079-91. ,</p>	1-47
	-/-	

1

INTERNATIONAL SEARCH REPORT

International Application No

PCT/US 99/25552

C-(Continuation) DOCUMENTS CONSIDERED TO BE RELEVANT

Category *	Citation of document, with indication, where appropriate, of the relevant passages	Relevant to claim No.
T	TAMURA M ET AL: "Structural correlates of an anticarcinoma antibody: identification of specificity-determining residues (SDRs) and development of a minimally immunogenic antibody variant by retention of SDRs only." JOURNAL OF IMMUNOLOGY, (2000 FEB 1) 164 (3) 1432-41. , XP000901556 the whole document	1-47



# INTERNATIONAL SEARCH REPORT

International application No.

PCT/US 99/25552

## Box I Observations where certain claims were found unsearchable (Continuation of Item 1 of first sheet)

This International Search Report has not been established in respect of certain claims under Article 17(2)(a) for the following reasons:

1.  Claims Nos.:  
because they relate to subject matter not required to be searched by this Authority, namely:  
**Remark: Although claim 42 is directed to a method of treatment of the human/animal body and claims 43-47 (all partially) are directed to a diagnostic method practised on the human/animal body, the search has been carried out and based on the alleged effects of the compound/composition.**
2.  Claims Nos.:  
because they relate to parts of the International Application that do not comply with the prescribed requirements to such an extent that no meaningful International Search can be carried out, specifically:
3.  Claims Nos.:  
because they are dependent claims and are not drafted in accordance with the second and third sentences of Rule 6.4(a).

## Box II Observations where unity of invention is lacking (Continuation of Item 2 of first sheet)

This International Searching Authority found multiple inventions in this international application, as follows:

1.  As all required additional search fees were timely paid by the applicant, this International Search Report covers all searchable claims.
2.  As all searchable claims could be searched without effort justifying an additional fee, this Authority did not invite payment of any additional fee.
3.  As only some of the required additional search fees were timely paid by the applicant, this International Search Report covers only those claims for which fees were paid, specifically claims Nos.:
4.  No required additional search fees were timely paid by the applicant. Consequently, this International Search Report is restricted to the invention first mentioned in the claims; it is covered by claims Nos.:

Remark on Protest

- The additional search fees were accompanied by the applicant's protest.
- No protest accompanied the payment of additional search fees.

# INTERNATIONAL SEARCH REPORT

Information on patent family members

Inter. Patent Application No

PCT/US 99/25552

Patent document cited in search report	Publication date	Patent family member(s)	Publication date
WO 9726010 A	24-07-1997	AU 706397 B	17-06-1999
		AU 1830897 A	11-08-1997
		CN 1213312 A	07-04-1999
		HU 9900396 A	28-05-1999
		NO 983284 A	16-09-1998
		PL 327929 A	04-01-1999
		US 6005091 A	21-12-1999
		ZA 9700347 A	06-10-1998
WO 9613594 A	09-05-1996	US 5889157 A	30-03-1999
		US 5981726 A	09-11-1999
		US 5608039 A	04-03-1997
		AU 4135596 A	23-05-1996
		CA 2203236 A	09-05-1996
		EP 0796334 A	24-09-1997
		JP 10508202 T	18-08-1998
		US 5990296 A	23-11-1999
WO 9943816 A	02-09-1999	AU 6439398 A	15-09-1999

**This Page is Inserted by IFW Indexing and Scanning  
Operations and is not part of the Official Record**

**BEST AVAILABLE IMAGES**

Defective images within this document are accurate representations of the original documents submitted by the applicant.

Defects in the images include but are not limited to the items checked:

- BLACK BORDERS**
- IMAGE CUT OFF AT TOP, BOTTOM OR SIDES**
- FADED TEXT OR DRAWING**
- BLURRED OR ILLEGIBLE TEXT OR DRAWING**
- SKEWED/SLANTED IMAGES**
- COLOR OR BLACK AND WHITE PHOTOGRAPHS**
- GRAY SCALE DOCUMENTS**
- LINES OR MARKS ON ORIGINAL DOCUMENT**
- REFERENCE(S) OR EXHIBIT(S) SUBMITTED ARE POOR QUALITY**
- OTHER: \_\_\_\_\_**

**IMAGES ARE BEST AVAILABLE COPY.**

**As rescanning these documents will not correct the image problems checked, please do not report these problems to the IFW Image Problem Mailbox.**